

MADE IN AUSTRIA
axelbloom
german schlafsysteme

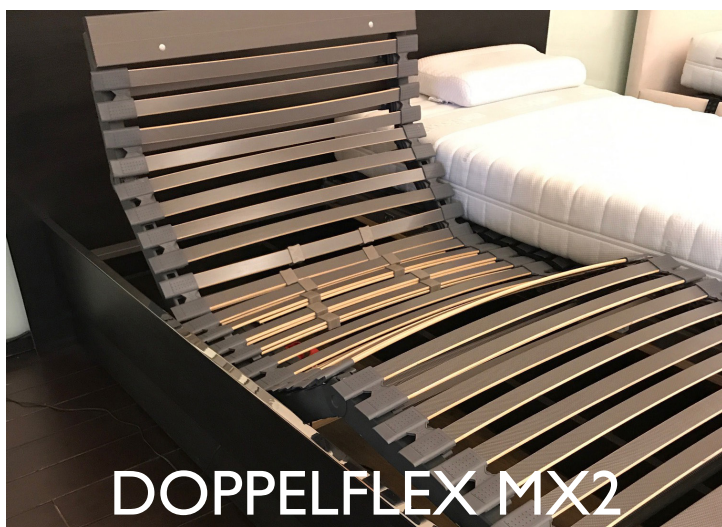

RV INSTALLATION GUIDE FOR ADJUSTABLE BEDS



DOPPELFLEX MX2



QUATTROFLEX MX2



UBERFLEX MX3



UBERFLEX MX4

LUXURY SLEEP RV
“Sleep on the Road Never Felt So Good”

RV INSTALLATION OPTIONS



PREVOST XL2



TIFFIN PHAETON



**UBERFLEX MX3
THREE MOTOR SYSTEM**



**KING SIZE
QUATTROFLEX MX2**



LANDMARK 365



**GULF STREAM MONTAJ
LUXURY COACH**



**SHORT KING SIZE
QUATTROFLEX MX2**

**SHORT KING SIZE
SILVERSTAR MX2**



**SHORT QUEEN SIZE
QUATTROFLEX MX2**

RV INSTALLATION OPTIONS

Standard Installation on Platform Bed

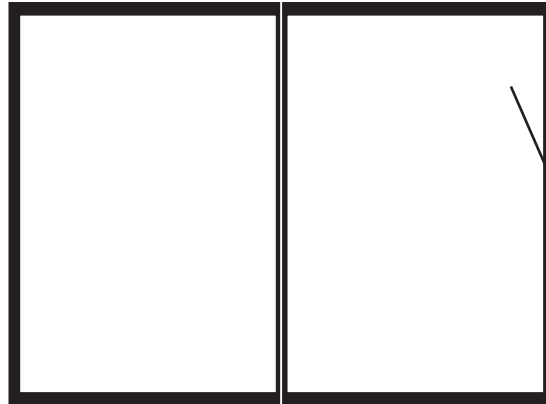

Place two half suspension on platform bed

Available Frame Lengths
74 inches to 80 inches



L-shape Brackets
to secure platform



Pull-out storage
drawers

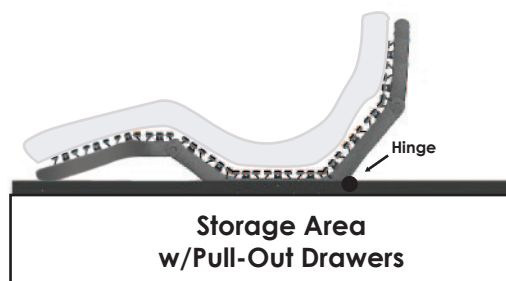

RV INSTALLATION EXAMPLES

Installation for Elevated Storage Access

Place Two Half Suspensions on Platform Bed

OPTION 1
(Normal Frame Length)

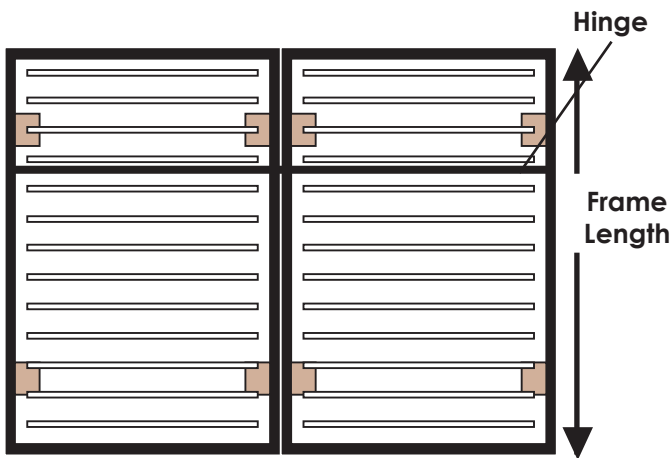

OPTION 2
(Custom Shorter Frame Length)

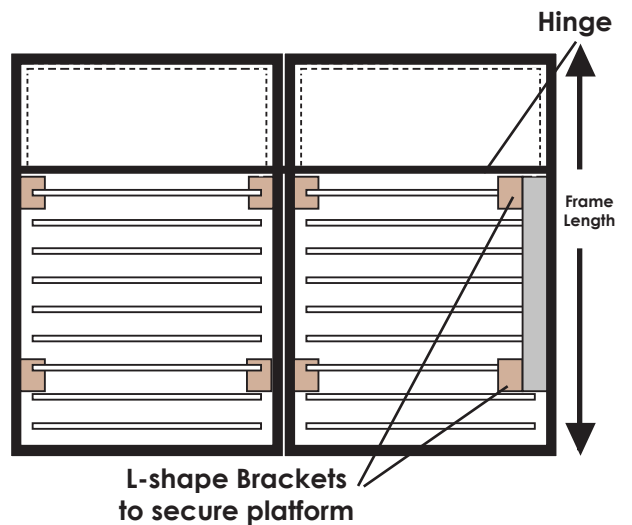

Normal Frame Length

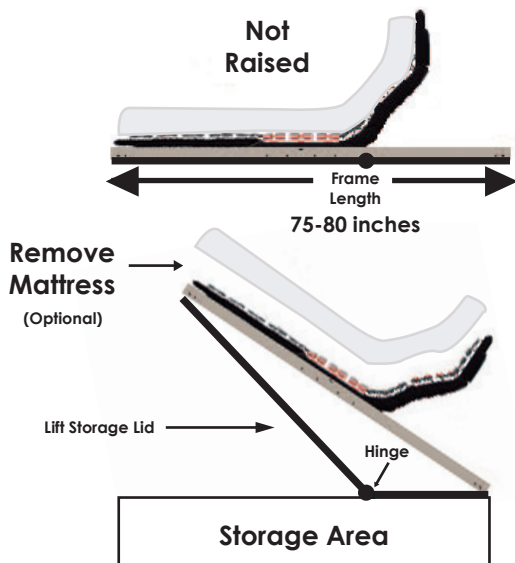

Custom Shorter Frame Length

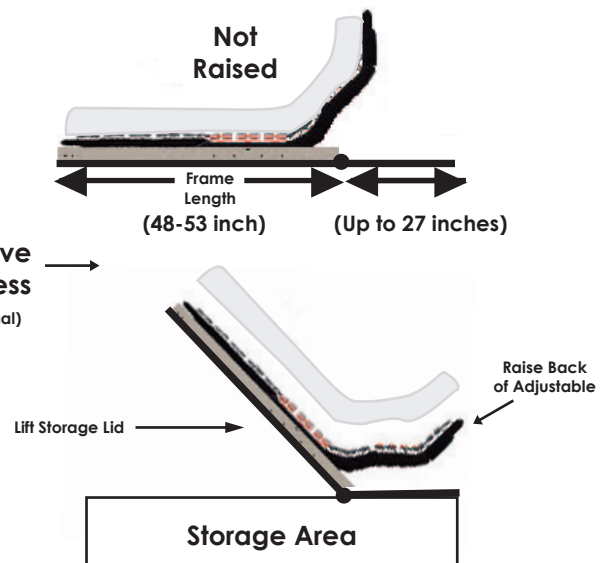

RV INSTALLATION OPTIONS

Example: Installation for Elevated Storage Access

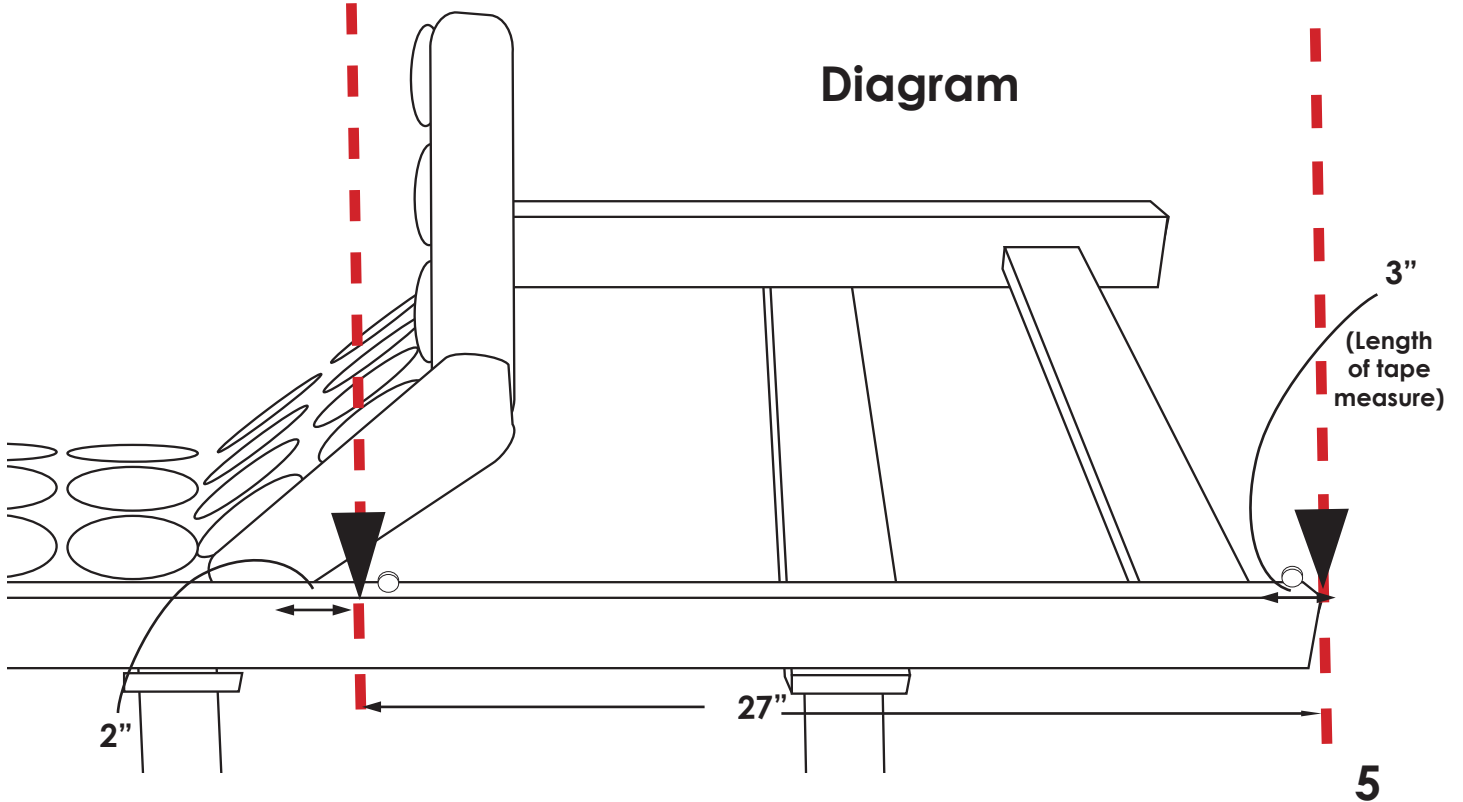

ADJUSTABLE BED ON STORAGE PLATFORM

How to Access Storage Compartment?

Example: Doppelflex With Shortened External Frame
For Access to Storage

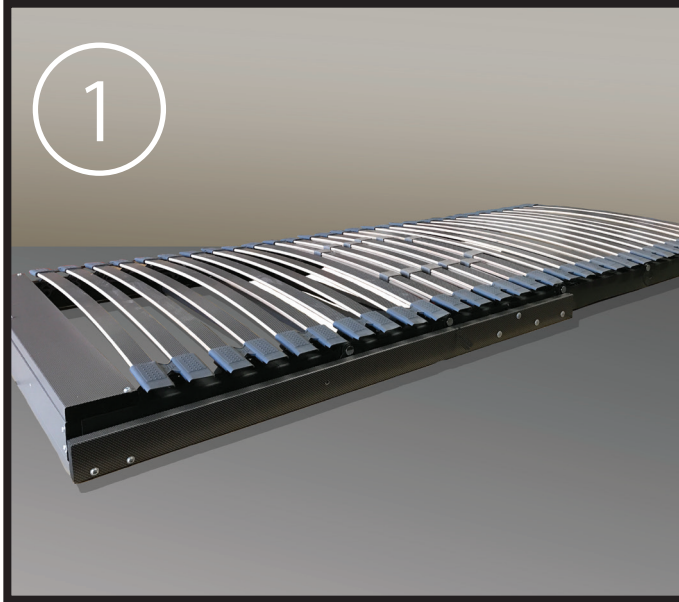

Flat Position

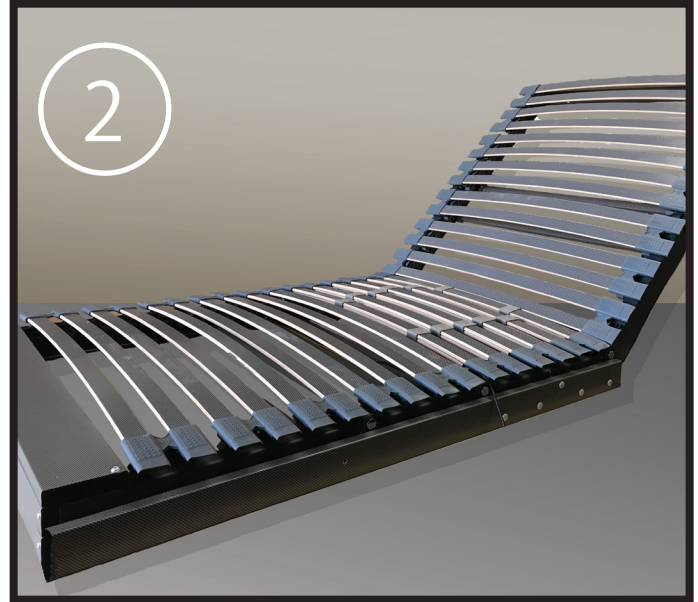

Back Raised Up

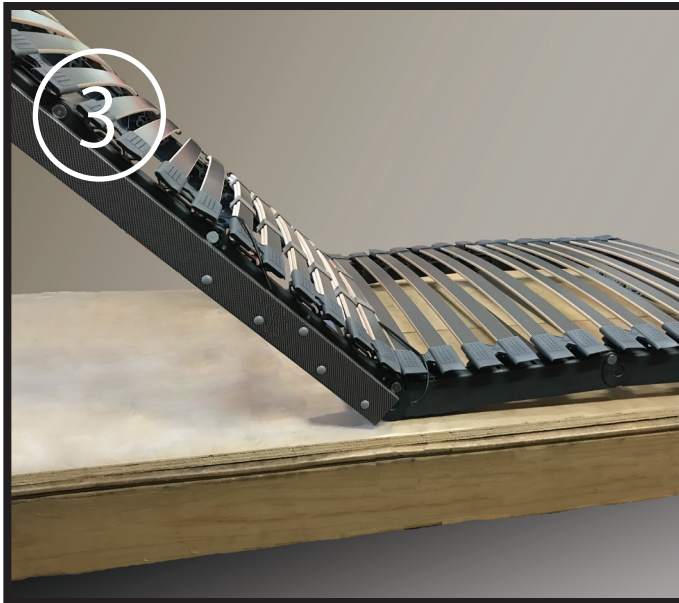

With Foot/Platform Section
Tilted Up for Access to Storage
(After Raising Back)

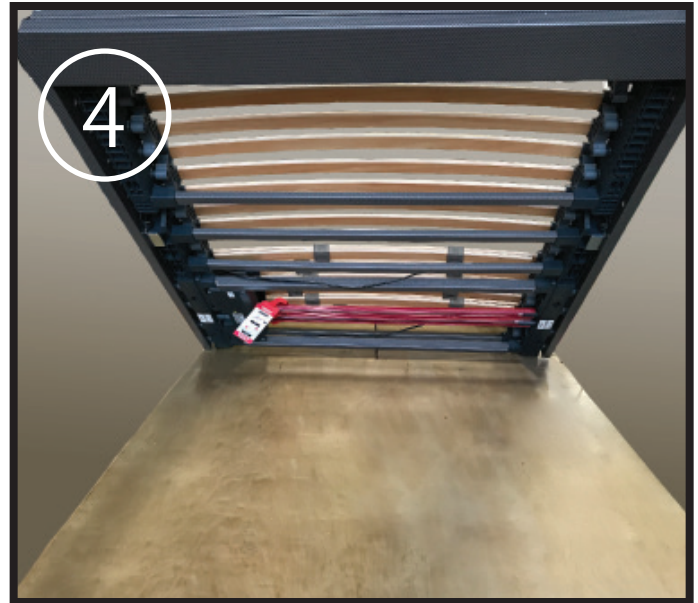

View Looking at Raised
Foot Section

ADJUSTABLE BED ON STORAGE PLATFORM

How to Access Storage Compartment?

Example: Doppelflex MX2 External Frame Can Be Screwed On Top of Existing Platform

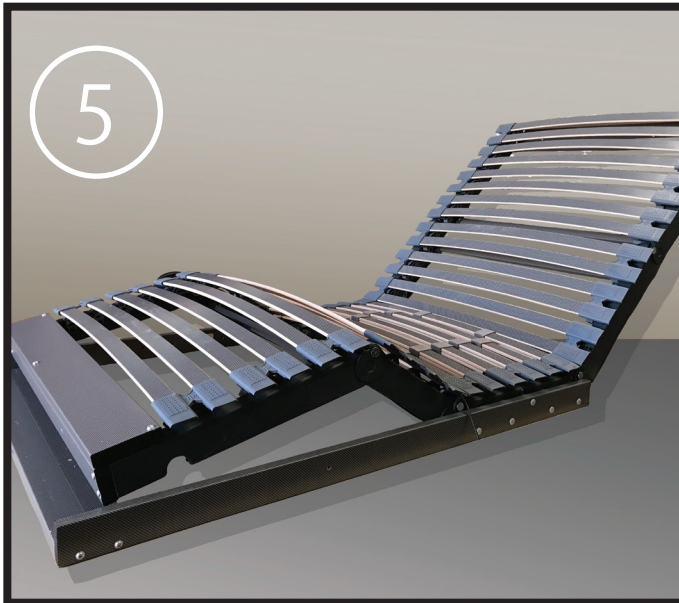

Foot and Back Raised Up

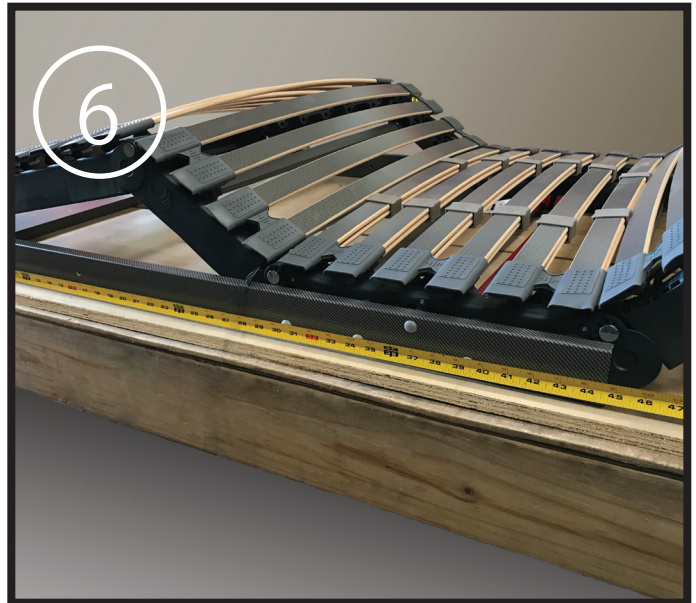

Side Profile Showing Length from Foot to Hinge Position About 44.5 Inch (Customizable)

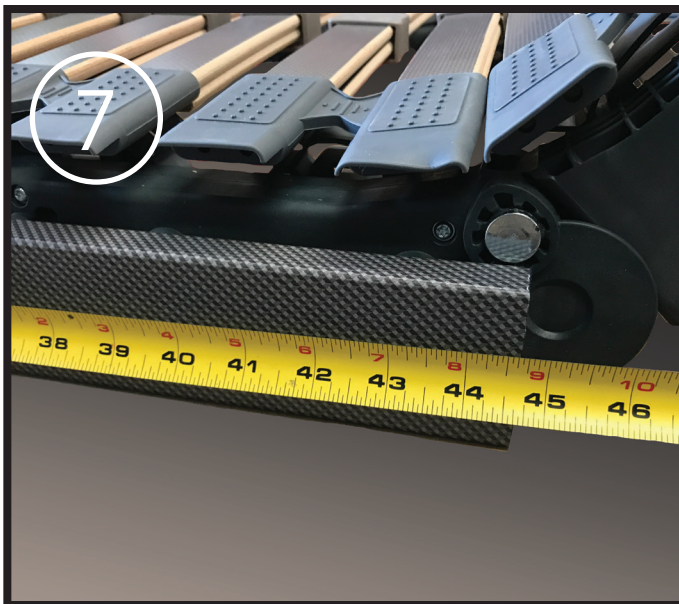

Close Up of Hinge Location

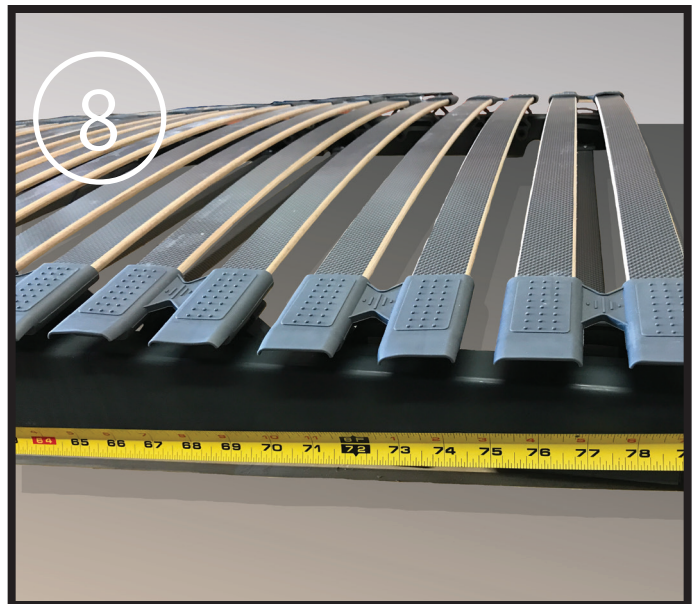

View Looking at Head Section

SIZE OPTIONS



TIFFIN PHAETON

Custom Split King
(2 x 36 x 80")



PREVOST XL2

Standard Split King
(2 x 38 x 80")



LANDMARK 365

Custom Split King
(2 x 36 x 79")



GULF STREAM MONTAJ

Custom Split Queen
(2 x 30 x 75")

SIZE OPTIONS

A. Queen Size

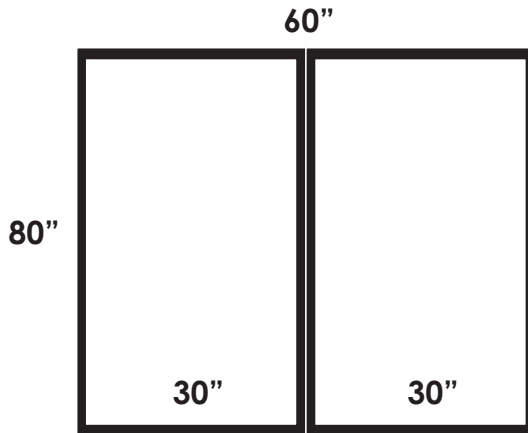

B. Short Queen Size

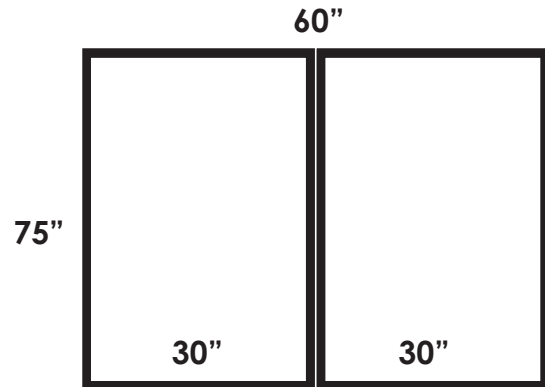

C. King Size

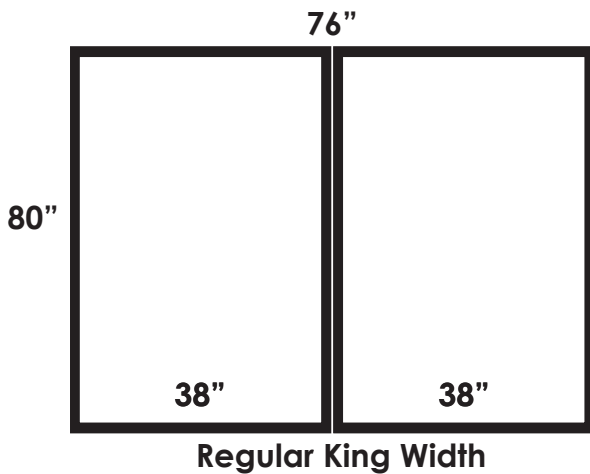

D. Short Cal King Size

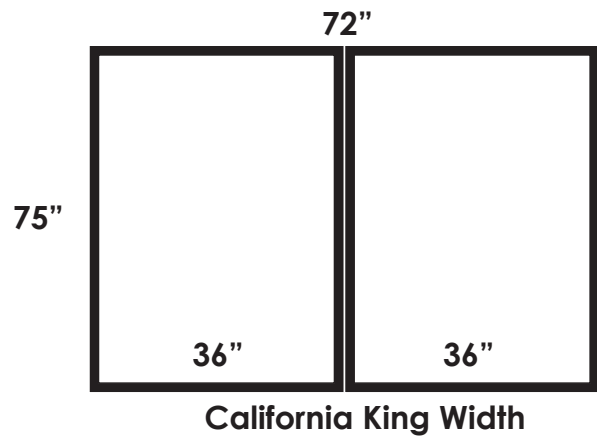

E. Custom Sizes

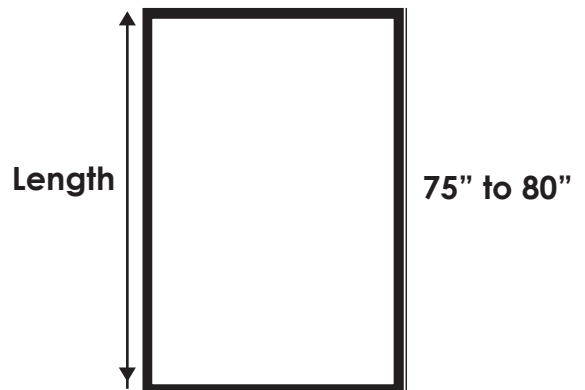
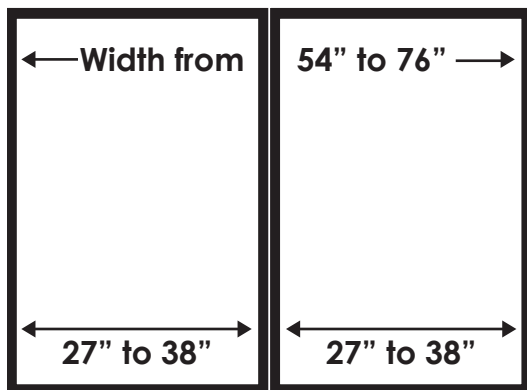

RV INSTALLATION GUIDE

Examples:
Standard Frame Length 80 Inch

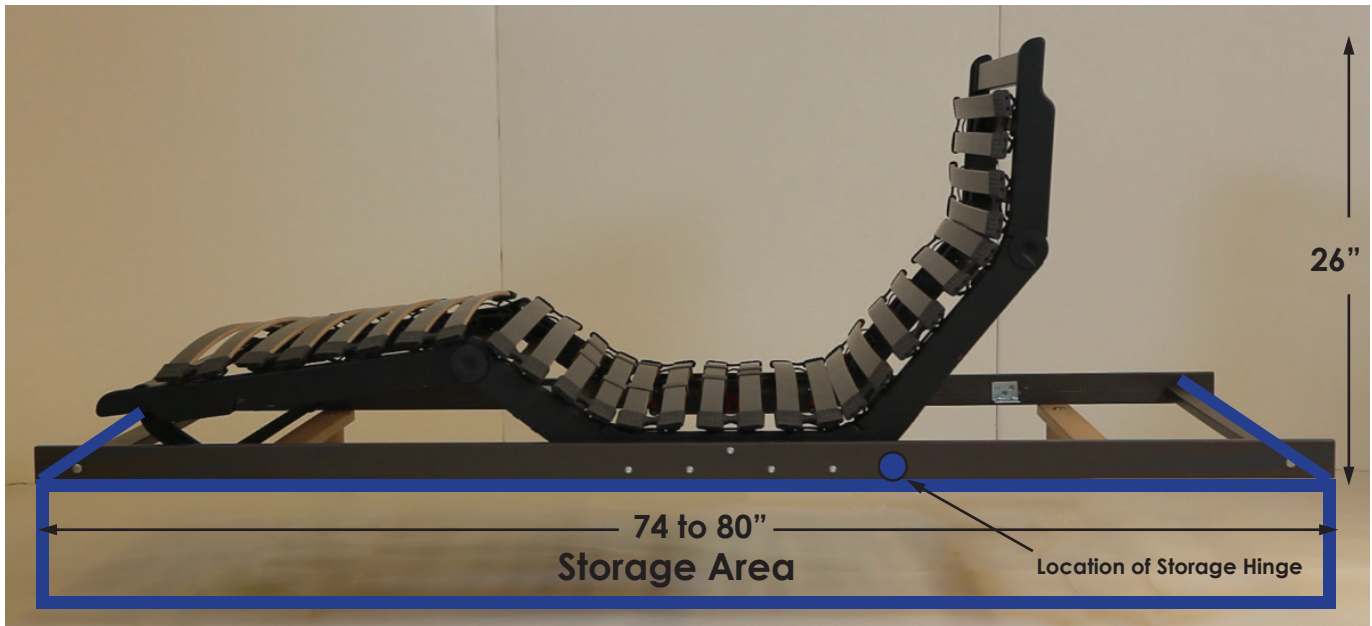

Length Can Be From Approx. 74 to 80 Inches
Shorter Frame Length 53 to 70 Inches

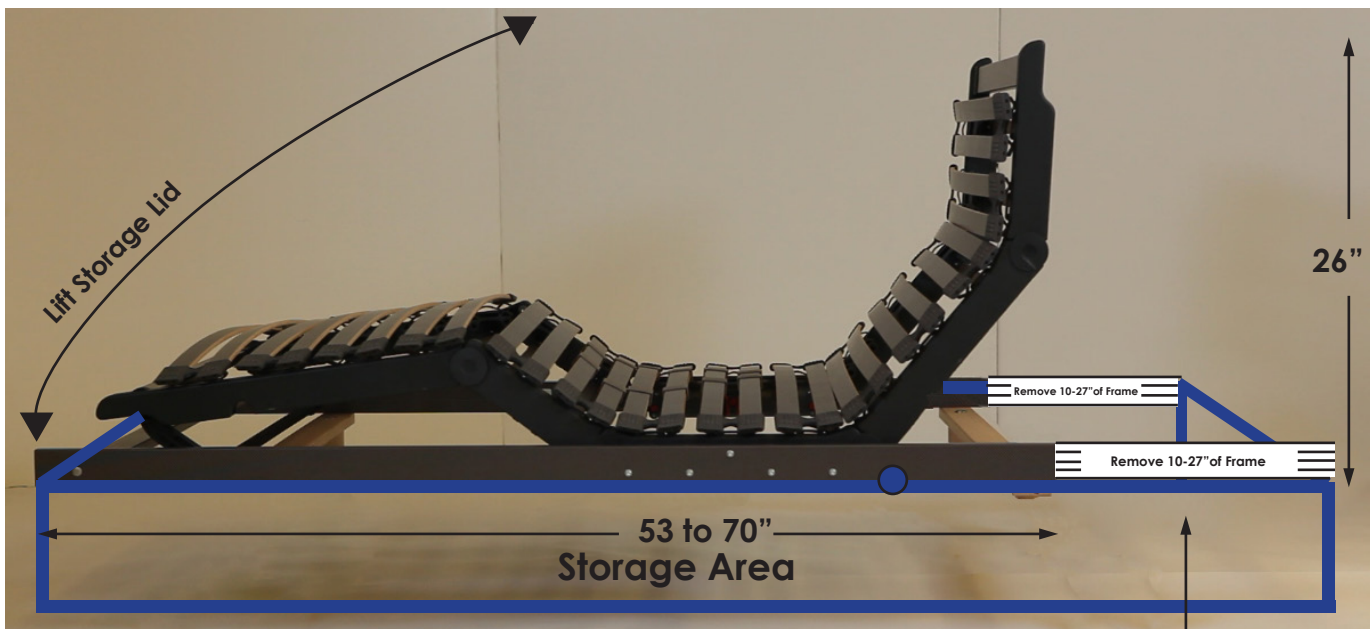

Shorten by 10-27\" for Elevated Storage Access

RV INSTALLATION GUIDE

Example: Shorten Frame by 27 Inches to Lift Storage Lid

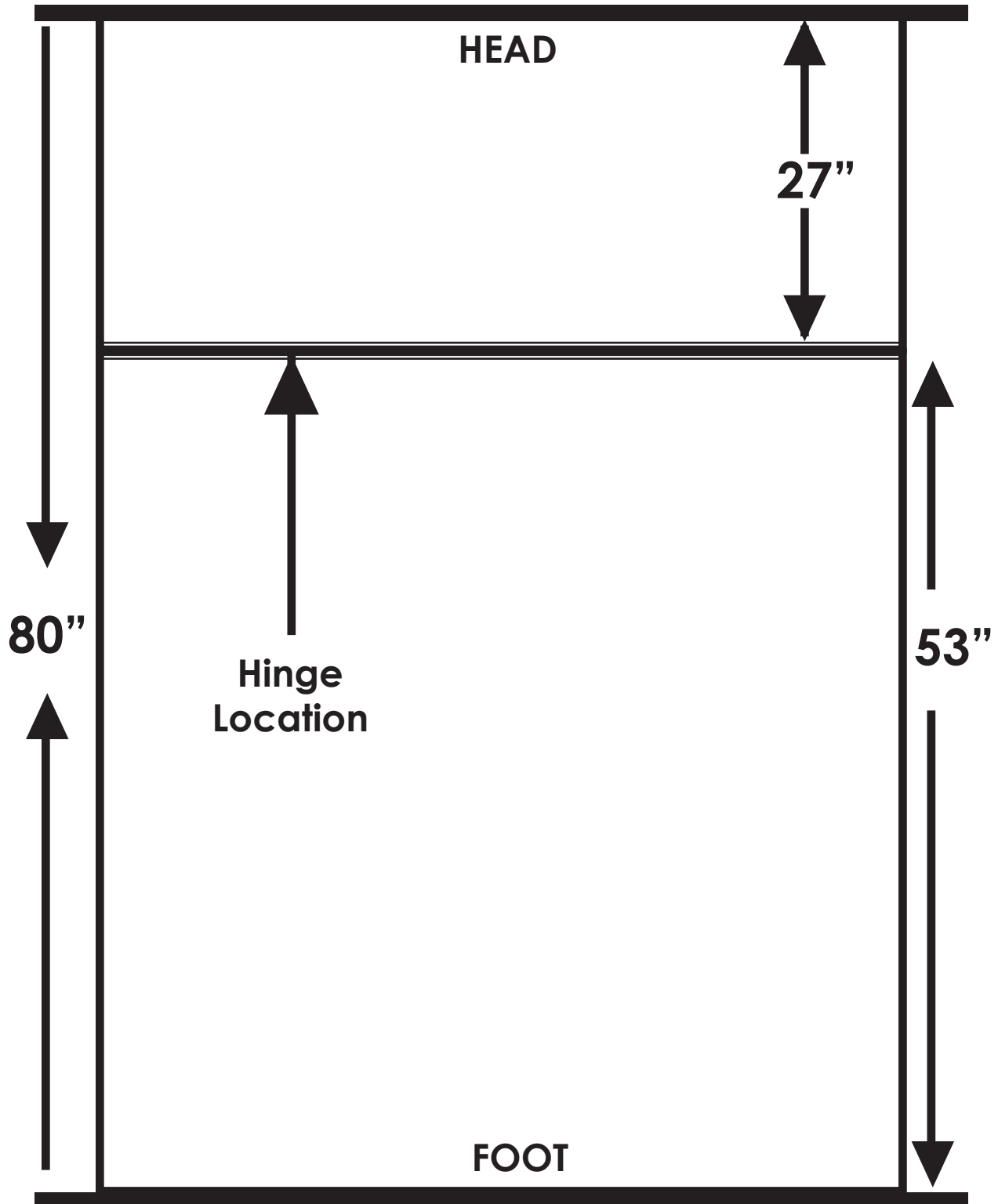

Why not **Sleep on the Best?**



Axel Bloom LLC

1105 Gayley Avenue
Los Angeles
California 90024 USA
Phone: 1-866-696-8387
www.axelbloom.com