



WILLKOMMEN!



Axel Bloom ergonomic sleep systems are developed from advanced **German technology** for the most luxurious sleep. They are designed to provide excellent back, shoulder and neck support using hypoallergenic foam mattress, micro-spring technologies and adjustable slat suspension systems.

Our sleep systems are designed and manufactured by German and Austrian bed systems suppliers who have been in business for over 50 years.

Axel Bloom is a **complete bed specialist** which means we have US-size bed systems and can provide motorhome and European-size custom beds. We have a broad range of models: seven mattress families, four types of slat suspension systems and 20 contemporary all-wood and fabric bed frames.

The slat suspension systems have flat and **electric adjustable** head, shoulder and leg controls with programmable functions for optimal back support and convenient positions to read, watch TV or simply enjoy a wonderful sleep.

We have the most advanced mattress and bed support design and manufacturing technology. These systems are made in modern factories in Germany and Austria by people with **a passion for precision and design.**

Finally, our most important objective is to fulfill the customer's most important expectation - **a wonderful, restful sleep!** We take pride in our commitment to provide a sleep solution which customers can look forward to enjoying every night.

Axel is a Scandinavian and German given name. It is a Scandinavian form of Absalom, meaning "Father of peace."



WHY DO AXEL BLOOM SLEEP SYSTEMS PROVIDE A SUPERIOR SLEEP?

An Axelbloom Sleep System addresses the objective by combining three **ELEMENTS**.

- 1. Mattresses Cores which are designed with complex shapes and layers of different material.** The complex cut allows the shoulders, back, and hip to be cradled correctly. Air channels are shaped into the mattress to foster continuous circulation as the body moves through the sleep cycle. The mattresses are light and double-sided so they can be flipped regularly to enhance durability.
- 2. Mattress Suspensions provide additional body contouring support.** No different than sophisticated car suspensions, Axelbloom uses specialized suspension components to firm up or soften different body regions. The suspensions can be fine-tuned for future changes in weight and body condition
- 3. Sustainable Mattress Covers that are washable and woven from natural TENCEL® fibers to be luxurious, hypoallergenic, breathable, and durable.** Instead of “wearing” the same bed cover for years, you can unzip, machine-wash, and dry your covers for a healthy and clean-smelling sleep for years.

Together, they provide a unique CUSTOM body support that is cool, breathable and clean for a luxurious sleep.

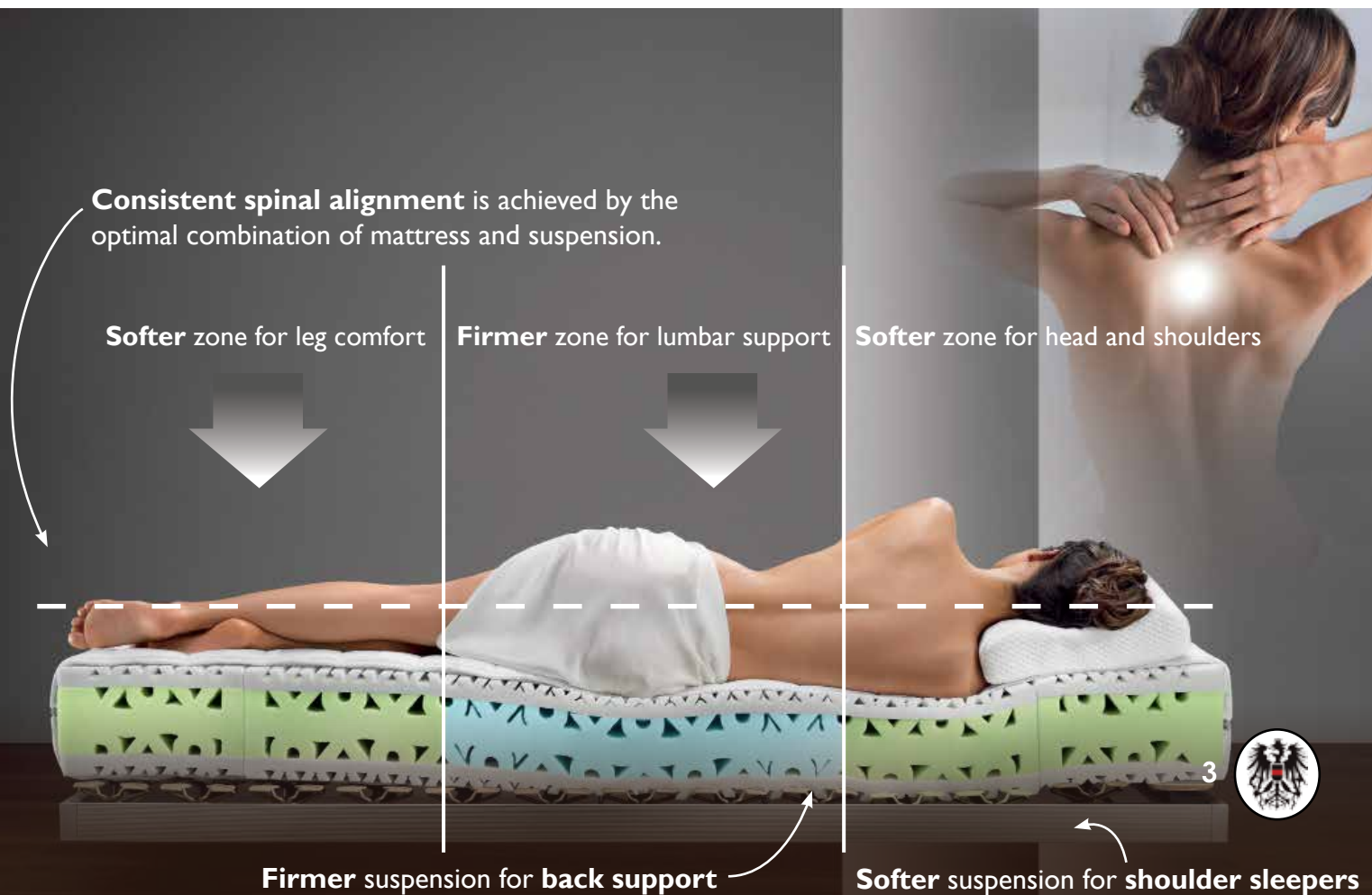

WHAT IS SPECIAL ABOUT OUR MATTRESS?

The mattress Core has a Unique Honey-Comb Structure for Back Support and Superior Comfort

- Our mattresses consist of a mattress core and a mattress cover.
- The mattress core conforms to the body to provide **superior ergonomic support from complex honey-comb type structures** which are cut into the cores.
- These honey-comb cells are **precision-cut** to different sizes to fill in the air spaces of the body differently from the head, to the shoulder (for shoulder sleepers) and back for **optimum spinal cord alignment**.
- **The cores are made of multi-layers of Kaltschaum (Coldfoam) or Hybrid compositions (micro-springs and foam structure).**
- Surrounding the cores are additional layers of foam and the thick woven mattress cover which are all designed for continuous airflow.
- **A cool sleep, superior breathability** and wicking away of moisture are achieved with air **channels** cut on the top and bottom layers of the mattress core.

Mattress Covers can be Unzipped and Washed

- Unlike traditional mattresses, our **mattress covers can be cleaned** to keep your sleep environment fresh and clean of perspiration, dust and stains
- The covers can be unzipped into two parts and washed in a washing machine and air-dried or machine-dried.
- This also maintains the supple support and longevity of the cover and removes buildup of moisture and mildew within the mattress.

Excellent Durability from the Best Quality Materials and Processes

- A key process to make the mattress and cushion core is to ensure that **the materials used are clean of impurities. Making Foam or Latex cores is similar to making bread. A key ingredient is Purified Water.** It has to be purified so the foam and latex micro-cells are strong and not compromised in rebound properties over time. Impure water and other materials will weaken the **cell walls of foam or latex** resulting in the material collapsing over time and therefore not returning to its original shape and strength. Impure foam cell walls will not retain strength, shape and support properties.
- **Our foam can be recycled and contribute to a more sustainable environment.**



SLEEP LIKE YOU HAVE NEVER SLEPT BEFORE

“Cool, Light & Washable”

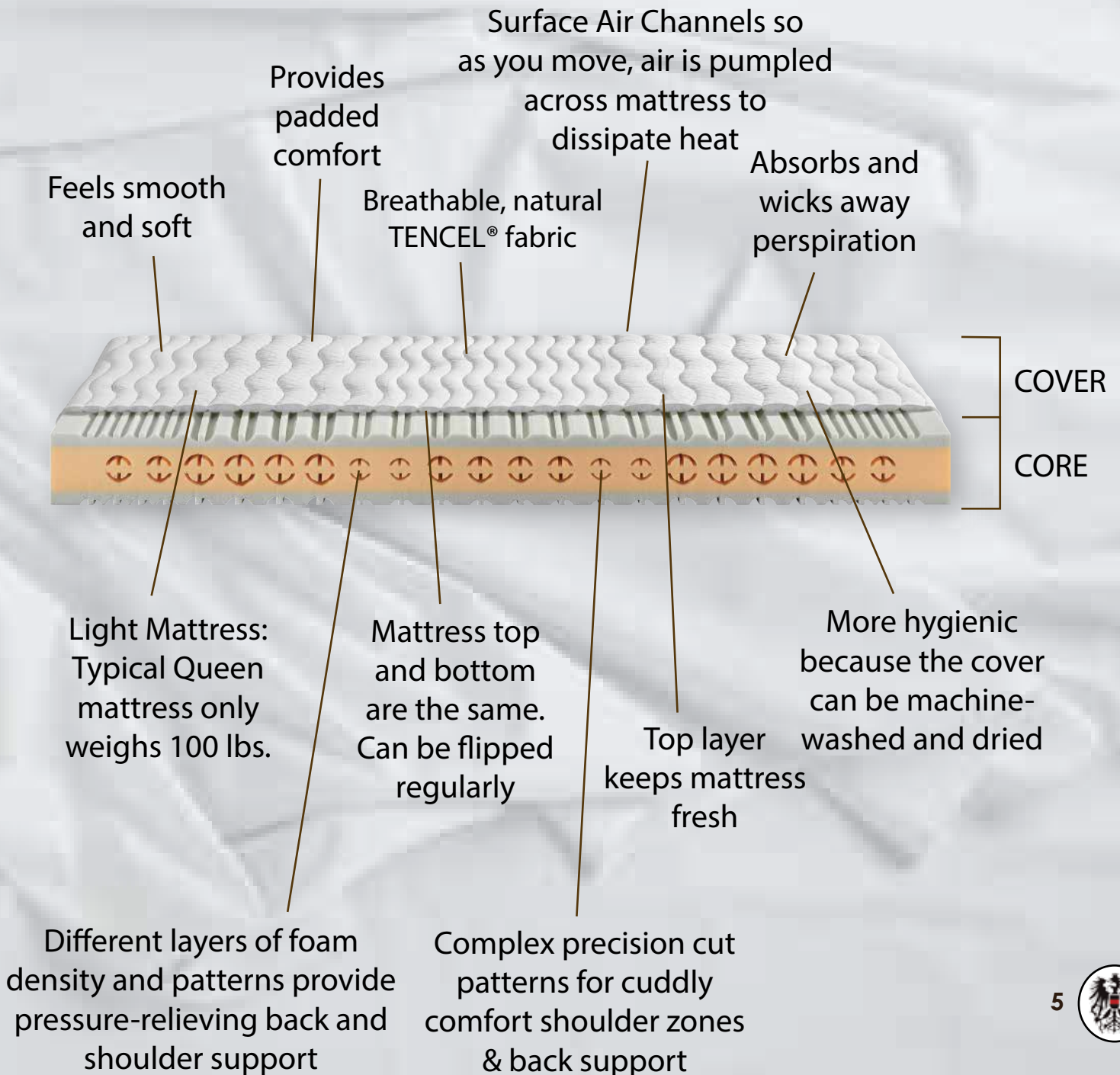



MATTRESS COVERS MADE FROM NATURAL **TENCEL®**

“The New Age Natural Fiber from Austria.”

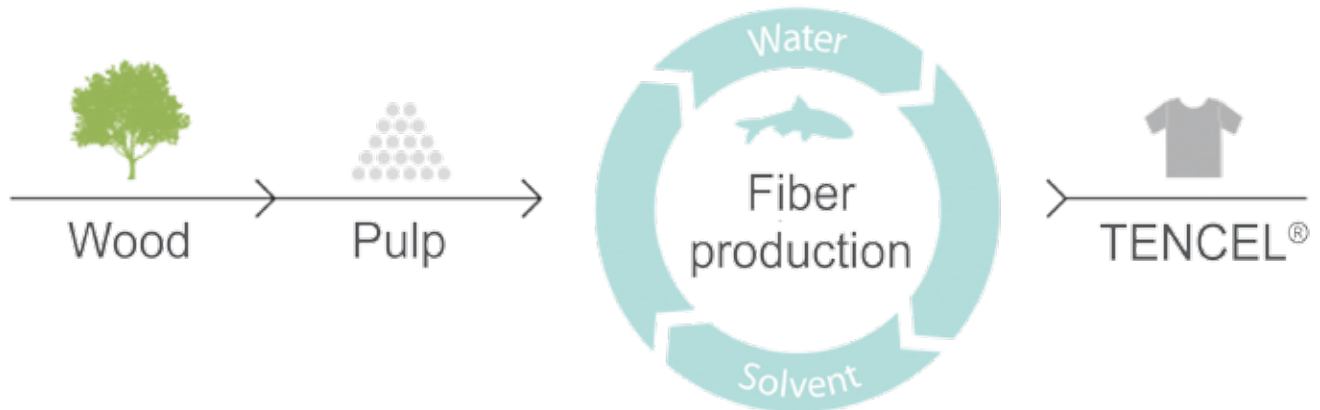

TENCEL® is the functional fiber from nature. It is of botanic origin, since it is extracted from the raw material wood. Textiles of TENCEL® are more absorbent than cotton, softer than silk, and cooler than linen.

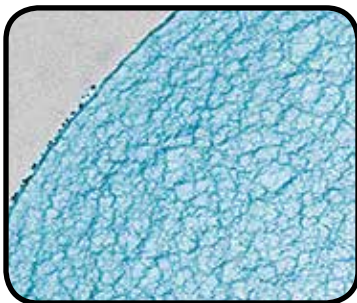

A TURBO FORCE IN MOISTURE ABSORPTION

TENCEL® has a unique fibril structure. Fibrils (extremely small hairs) are the tiniest components which make up the fiber. Submicroscopic channels between the individual fibrils regulate absorption and release of moisture. Thus, these tiny fibrils assure the optimum transportation of moisture.



TOTALLY NATURAL HYGIENE

With TENCEL® the formation of bacteria is reduced. Moisture is immediately transported into the inside of the fiber. Thus, no moisture film, which can sustain bacterial growth, forms on the fiber.



USING NATURE'S FIBER TO COCOON YOUR BODY

TENCEL® COMPARISON

Since the textile has a smooth surface, the softness is appreciable and prevents irritations to the skin. Thus, TENCEL® promotes an optimal skin feeling thanks to the smooth fiber surface. Rough fiber surfaces can cause skin irritations. Compared to the fiber surfaces of cotton and wool, it is clear that TENCEL® is much smoother and softer on the skin.

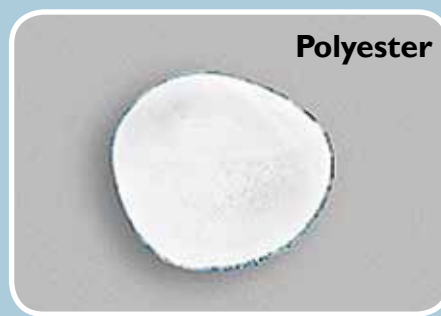
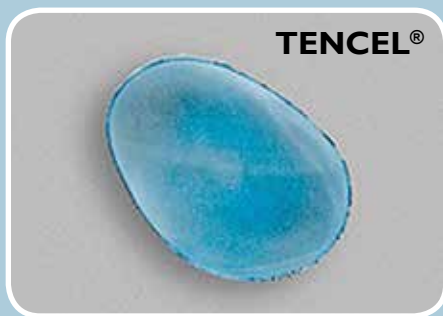

The applications for TENCEL® are exceptionally versatile. The fiber can be used in every aspect of sleeping – beginning with mattresses and mattress pads to bed covers and linens, all the way to lingerie. TENCEL®'s universality makes it possible to enjoy a completely botanic bed from nature. Nothing is dreamier than that when you go to sleep in a botanic TENCEL® bed.



MATTRESS OPTIONS

All our mattresses are double-sided and can be flipped over



DW200

- Most popular All-Rounder mattress
- 3 Layers of Cold Foam with surface air channels
- Mattress stays cool as you move
- **Firm** (7") Cold Foam Mattress



DW800

- Complex geometric cuts for body contouring
- More than 20 air holes with vertical cuts for superior body contouring and shoulder comfort
- Comfy **Medium-Firm** (7") Cold Foam Mattress

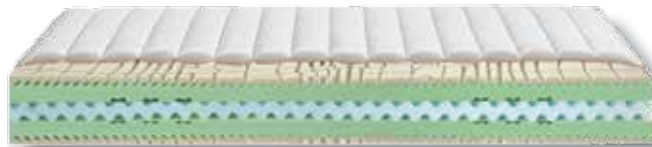

DOPPELMAT

- 5-Layer Cold Foam Mattress
- Provides superior back support and comfort
- 4 medium-soft layers encase a firm, wavy core
- **Medium-Firm** (8")



BERLIN

- Hybrid Mattress consists of the best of both worlds: 100s of microsprings are encased by 4 layers of wave-like Cold Foam to create the most luxurious and stable structure for the best sleep (8")
- Available in **Medium-Firm** and **Firm**

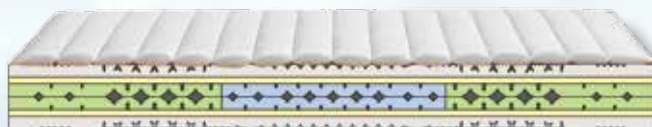

QUATTROFLEX

- Designed for luxurious sleep with high performance and coolness features
- 5 Layers and 10 firmness zones combine a top layer of Cold Foam and inner layer of Memory Foam with dynamic cut patterns for the most sophisticated mattress
- Our thickest mattress. Luxurious **Medium-Firm** (9")

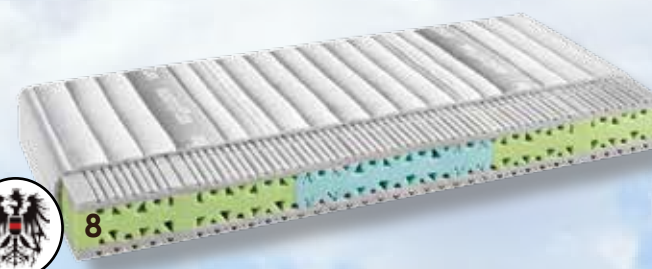

AUSTROFLEX AFX EMC 180

- The mattress core consists of 3 separate sections so each section does not pull the adjacent section
- Designed to cradle painful shoulder & necks
- New sectional concept promotes ergonomic adjustment at the shoulder/head body zones
- Available in **Medium** (7") and **Medium-Firm** (7")
- Cold Foam Mattress

SUSPENSION AND MATTRESS COMBINATIONS

“You wash your pajamas, so why not your mattress covers?”

1 **NATURAL TENCEL® FABRIC**

Axel Bloom uses luxurious Tencel® fabric in every mattress cover. Tencel® is a natural material made from the pulp of a tree that has many unique qualities, including:

- Wicks away moisture
- Keeps you cool
- Breathable
- Lightweight
- Soft

2 **COMPLEX WEAVE**

Superior weave technology allows for micropores which wick away moisture and aid in breathability of mattress core.



3 **HYGIENIC & WASHABLE**

All Axel Bloom covers are washable. This keeps the mattress free of mildew, dust and sweat. Our covers unzip into two halves making them easy to be washed and dried. Regular washing will extend the life of your mattress by protecting the mattress core.



WHAT IS SPECIAL ABOUT OUR SUSPENSION SYSTEMS?

“Can you imagine driving a car without a suspension?”

Our suspensions, not only raise your body, they have special contouring and support suspensions. Like a car suspension, they adjust to follow the natural contour of your body. This unique adjustability offers custom pressure adjustment for body ache, side and back sleepers.

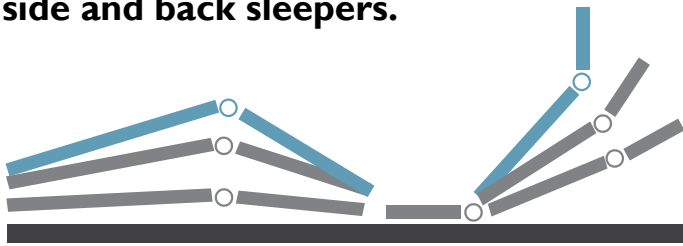

- **Our slat and pod suspension systems look like aerospace frames.** The support mechanisms look like a lattice frame with wooden slats, rubberized suspension systems and advanced polymer pod designs for optimal body support. The shoulder and hip regions are cradled with softer suspension elements than the back and head, which require a more stable, firmer support.
- **People with specific conditions: GERD, acid-reflux, shoulder and back ailments** can achieve enhanced sleep comfort by selecting from our wide choice of advanced suspension systems and matching them with our mattress.
- We have the **widest choice of adjustable bed slats in all sizes** from traditional slats to advanced pod suspensions and electric adjustable bed frames. There are 30 possible adjustable and mattress combinations.
- We have the **largest number of German adjustable bed models to suit all types of body types.** They range from two to eight electric motor models.
- Each suspension frame is cut with precision using CAD/CAM machines (computer-aided design and computer-aided manufacturing) and assembled individually for each customer.

The **Open-Air Suspension** replaces a box spring. It consists of slats and pods.

Flexible Slat Suspensions

- Over 50 slats continuously flex to align your body's spinal cord, shoulder and back region
- The slats can be configured to be firmer or softer in the lumbar region
- Every two slats adjust to comfort pressure points across the body.

Open-Air Pod Suspension

- More than 30 individual pods flex to soften pressure points and straighten the spinal cord
- There are 4 pod firmness elements
- Each pod can be swapped to different positions to fine-tune support.



AXEL BLOOM SLAT SUSPENSIONS

Every two slats are secured at each end by a flexible holster that contours to your body. For example, a half-king (Twin XL) Doppelflex MX2 section has 28 slats consisting of 14 sets of 2-slats which flex from the top to the bottom of the slat suspension. The range of flex is up to 20 degrees from the horizontal, in both directions. Each set of slats flexes to provide the correct support to align your spinal cord for pressure relief.

Flexible holster at the end of each slat

SLATS FLEX WITH PRESSURE FOR FINE-TUNED SPINAL CORD COMFORT



AxelBloom's Slat Suspensions offer **unique firmness adjustments**.

You can move the sliders on the slats towards or away from the center to vary the firmness of the slats. So a tall person might wish to place the sliders for the lumbar slats, further away from the center to provide a firmer support for the back.

Slider moves to the center for softer setting

Slat for firmer setting

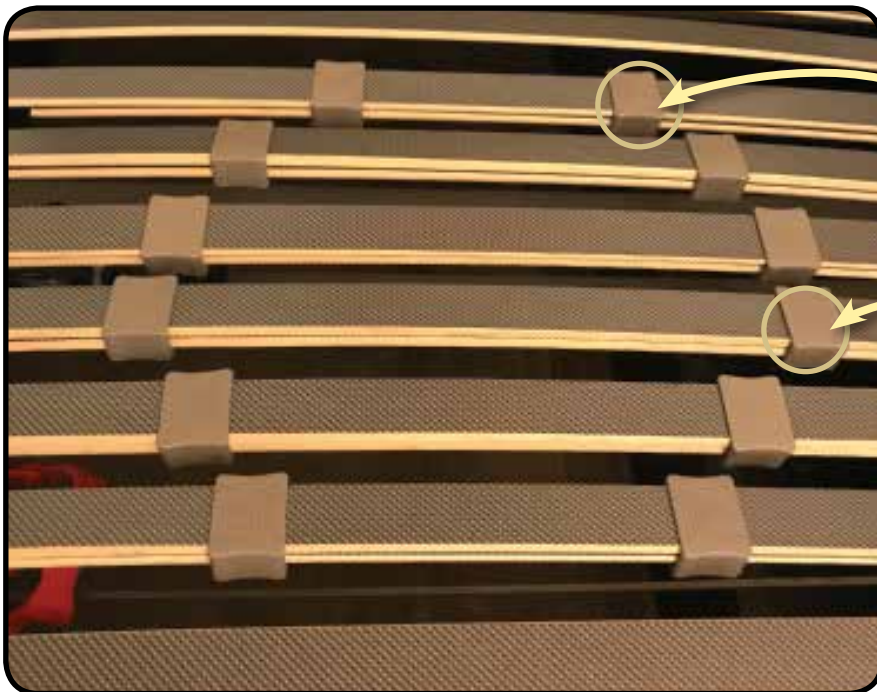

AXEL BLOOM PODS, INSPIRED BY NATURE

IMAGINE WAKING UP ON A BED OF ROSES

The four petals of every pod independently respond in all directions, yet are so stable that they create a smooth vertical motion that prevents friction where the elements meet the mattress.



Quattroflex Pods

- 30° tilt
- Three firmness settings categorized by pod color and inserts: white (soft), black (medium-firm), and black with red inserts (firm)
- 20 or more pods per suspension
- Like Lego™ building blocks, each pod can be interchanged

QUATTRO  **FLEX**
german schlaf technologie



The innovative geometry of the design provides unparalleled flexibility with multiple support points or "petals."



ULTIMATE ADJUSTABILITY FOR ULTIMATE COMFORT

Uberflex Pods



The Uberflex pods enhance the features of the Quattroflex pods. The flat supporting surface is segmented into four parts for more custom flexibility. Instead of inserting the red firmness adjuster, there is a red bezel integrated with each pod that can be rotated in three positions to change the firmness settings from soft to normal and firm.

- 20° lateral tilt in all directions
- Three firmness settings per pod.
- Adjust firmness by rotating red bezel from level I (soft), to level II (medium firm), to level III (firm).
- Choice of soft or firm pods which, in combination with the red bezel, offer **Six** levels of firmness settings.
- Most flexible pod design

Austroflex Pods

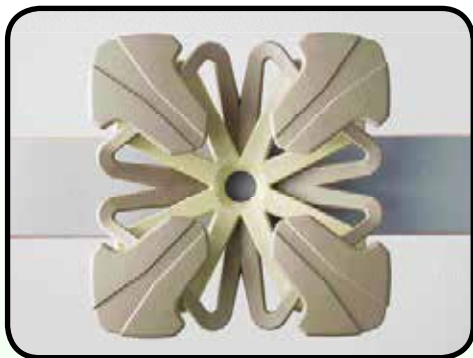
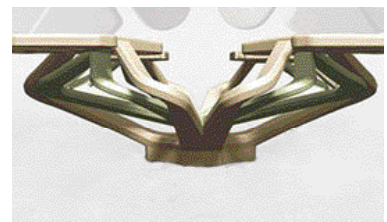
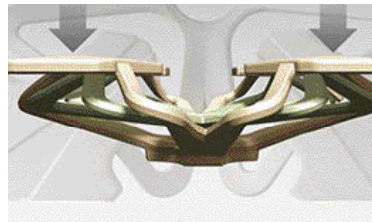

• 70+ Tectel cushion elements provide 288 support points to cushion your body

• Each cushion element consists of load-responsive material with a stable core and elastic outer casing

• The green firmness inserts provide more support to the lumbar region by reducing downward flex

• The softer green cushion elements can be swapped for the firmer coffee elements to fine-tune the suspension system

- 45° tilt
- Three firmness settings categorized by pod color and inserts: green (soft), brown (medium-firm), and brown with green inserts (firm).
- 70 or more pods per suspension
- The most luxurious design



INTRODUCING AXEL BLOOM ADJUSTABLE BEDS FOR HOMES AND LUXURY RVs



“Designed to transform your sleep experience forever.”

Axel Bloom is proud to offer the widest selection of adjustable bed options for **RVs and homes** to suit your health needs. Many health conditions such as GERD, asthma, acid-reflux, shoulder and back ailments can be alleviated by the right adjustable bed.

We offer many style, ranges of motion and **US, European and custom RV sizes**. Whether you need head, lumbar, or overall support, you can sleep in superior comfort in an Axel Bloom Adjustable Bed.



AXEL BLOOM ADJUSTABLE BED FEATURES

Doppelflex MX2



Austroflex EL3

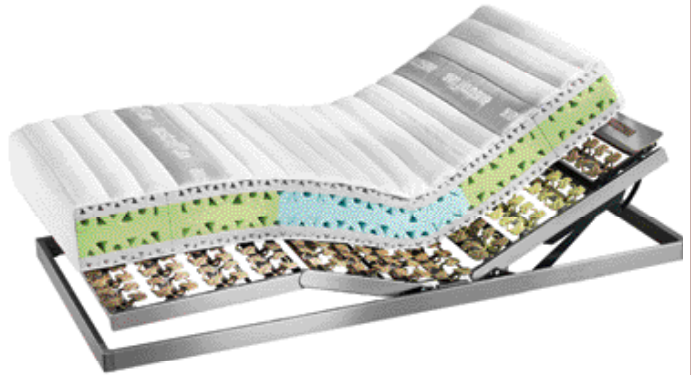

REMOTE OPTIONS

- Wired remote
- Wireless remote
- With or without memory settings

OPTIONAL FEATURES

- 90° head angle
- Very high foot elevation
- Very high angle of back elevation
- Independent head movement
- Low profile adjustable beds (5" thick)
- Can be placed on platform beds

FOUR SUSPENSION MODELS

- Doppelflex
- Quattroflex
- Uberflex
- Austroflex

SECTIONAL OPTIONS

- 2 Sections (back and legs)
- 3 Sections (head, back, and legs)
- 4 Sections (head, lumbar, knees and feet)

MOTOR OPTIONS

- Electric
 - 2 Motors
 - 3 Motors
 - 4 Motors

KING AND QUEEN SYSTEMS

- Two suspensions can be synchronized to adjust together as a king or queen.
- A queen bed consists of two synchronized half-queen sections
- A king bed consists of two synchronized half-king (two twin XL) sections

CUSTOM SIZES

- US Sizes
- European Sizes
- RV/Motorhome Sizes



DOPPELFLEX MX2 SLATS

The All-Rounder Adjustable System

The Doppelflex MX2 is an all-slat suspension with 4 motors for a King, Queen or custom system.

There are 28 slats on each suspension that rotate to fine-tune how your spinal structure is aligned.

Six of those slats can be adjusted for firmer or softer lumbar support.

Each section has two motors. One motor controls the head and lumbar regions. The second motor controls the leg and knee positions. Thus a King system with two sections has four motors. The motors are controlled by cable-connected remotes or an optional wireless remote, including the motor. Each section can be controlled independently or synchronized to move together.

The Doppelflex is **only 5 inches in height**.
Thus it can be placed flat on a floor, platform bed or boxspring.



Handheld cable remote controller and optional wireless RF controller.

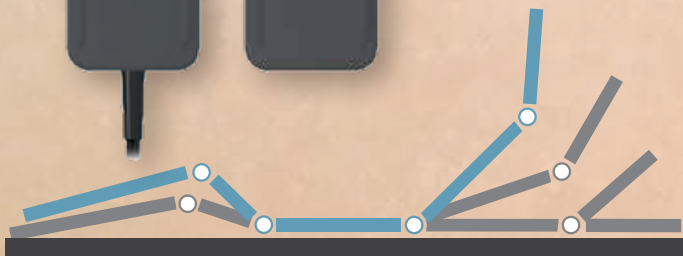

QUATTROFLEX MX2 HYBRID

The "4-Wheel Drive" Adjustable System

The Quattroflex MX2 is a versatile electric adjustable system with a hybrid suspension consisting of slat and pod elements.

There are **four motors** for a king or queen bed system. For example, a Half King is a standalone TWIN XL system that includes two motors. One motor controls the head, shoulder and back positions. The second motor controls the leg and knee positions. Therefore a **King size** adjustable system would consist of two Twin XL sections which include **four motors**. Each section is controlled by a cable connected or an optional wireless handheld unit, which is attached to the motor.

It can be placed on the floor, a platform bed or box spring. There are over 70 Quattroflex pods and 20 slats for a King bed. The slats rotate to cushion your head and leg regions. During your sleep cycle, as you move, each pod surface continuously adjusts to the body weight and position of the body to **optimally align and relieve pressure to your spinal cord**.

The four motors of a queen or king system can be controlled to adjust the head, shoulder, and leg positions.



Handheld cable remote controller and optional wireless RF controller.

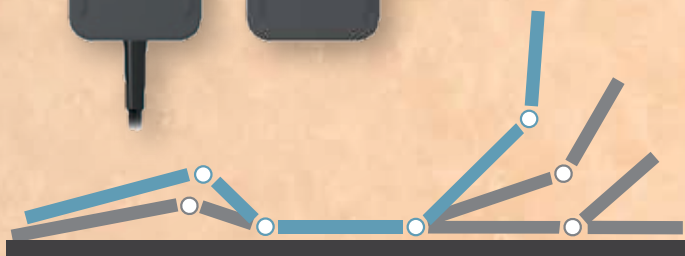

UBERFLEX MX3 HYBRID

Maximum Flexibility for Maximum Comfort The "6-Wheel Drive" Adjustable System

This system has **5** movable sections. Three sections are for the head, shoulder, and back. Two sections are to lift the thigh and knee regions. **Six motors** control the **10** movable sections for a king or queen bed. For each half king or queen section, one motor adjusts the head position. The second motor adjusts the shoulder and back. The third motor controls the two leg positions. Since there are two sections, there are a total of 6 motors. The frame, including the motor, is only 5 inches tall. Thus it can be placed flat on a bed or floor.

The Uberflex MX3 has our most flexible **suspension**.

There are two types of suspensions:

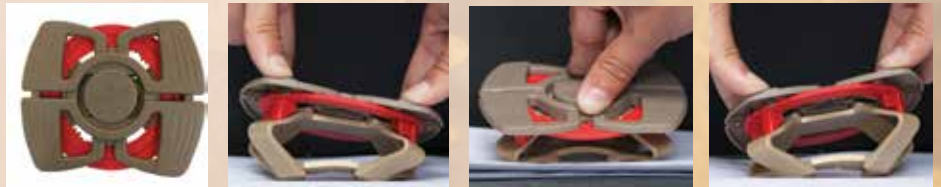

Rotating **Uberflex pods** and **flexible wooden slats**.

- There are more than 70 pods and 36 flexible slats for a King system
- In the back region, Uberflex pods can be adjusted to provide three levels of firmness



Flexible **slats**.

- The head, shoulder and leg regions have slats which provide firm support.

Each Uberflex MX3 suspension has a wireless handheld remote controller. It adjusts all the positions and has two-memory settings.

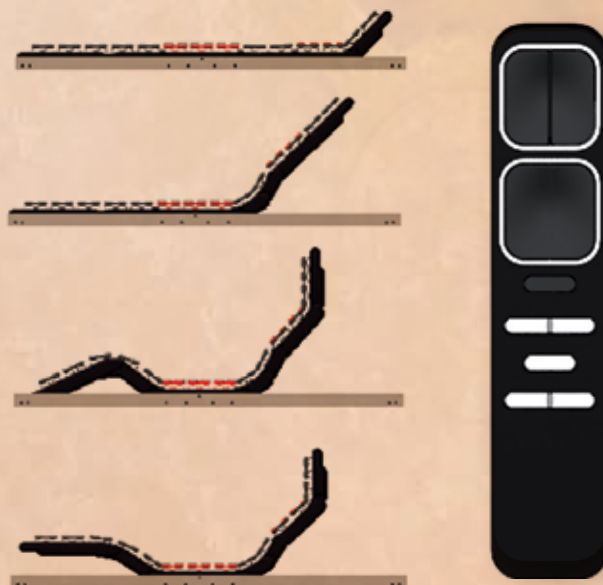

UBERFLEX MX4 HYBRID

The Most Advanced Suspension The "8-Wheel Drive" Adjustable System

The Uberflex MX4 has eight motors for a king or queen bed. It is the most advanced hybrid suspension.

There are two types of suspension: More than 70 rotating Uberflex pods and 36 flexible wood slats for a King system. In the lumbar region, Uberflex pods can be adjusted to provide 3 levels of firmness. The head, shoulder, and leg regions have flexible wooden slats which provide flexible, firm support.

This system has 5 movable sections. Four sections are to optimize comfort in the head, shoulder, and back. Two sections are to lift the thigh, knee, and foot regions. For each half king or half queen suspension, there are **six** motors which control the 7 movable sections. One motor adjusts the head lifting position. The second motor adjusts the shoulder and back. The third motor controls the thigh and knee. The final fourth motor lowers and raises the feet.

The frame, including the motor, is only 5 inches tall. Thus it can be placed flat on a platform bed or floor.



Adjustment



Time/Date



Memory



Light (on)



Light (off)

Settings



Wireless Remote

Each Uberflex MX4 suspension has a wireless remote controller. It has an LED screen with graphic images to guide the user to adjust positions, memorize two settings, turn on a remote light, and set the time.



AUSTROFLEX EL3

The Luxurious “6-Wheel Drive” Adjustable System

The Austroflex has 6 motors for a King System. The suspension consists of more than 70 Tectel elements that rest on 20 slats. It is designed for luxurious comfort, particularly in the head and shoulder regions.

One motor is dedicated to gently raise the head position, first vertically, and then by rotating the head section. In the shoulder region, the slats there are on springs that rotate as your shoulder moves side to side. For shoulder sleepers, the slats allow the shoulders to move down, resulting in aligning the spinal cord in a restful position.

The back can be raised to a 90 degree angle and the knees raised extremely above the head for improved blood circulation, thus simulating a “zero-gravity” effect.

Wired or optional wireless controllers are available with three memory settings. The motor is situated 5 inches below the frame so the total height of the frame, including the motor, is 10 inches.

The Tectel elements provide unsurpassed support for a cradling sleep experience. Each of the Tectel elements is shaped like a flower with four petals that gently flex to reduce pressure points and optimize spinal cord position.

There are 3 levels of Tectel elements: Soft, Medium, and Firm (when a firmness adjuster is inserted into an element).

All the positions of the elements can be interchanged to optimize the firmness requirement of the body in a precise location.

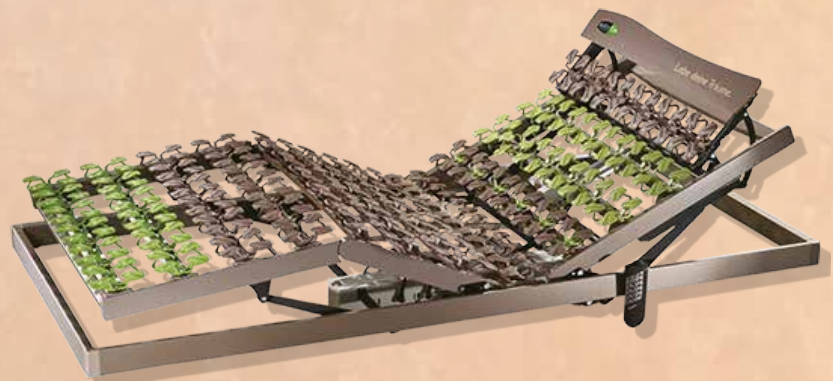

20

AXEL BLOOM FLAT SUSPENSIONS

QUATTROFLEX GT

The Quattroflex GT is a sophisticated suspension with multiple levels of user configurable firmness levels and comfort locations.

Each pod surface adjusts to the body weight and region in two ways. Each pod is suspended such that it can tilt and bend to the position of the body in a continuous and smooth angle to provide the least pressure to the spinal cord, back and hip. The pod suspensions are arrayed in 14 rows of slats. The Quattroflex GT can be placed directly on a box spring or platform bed. It provides a flat surface and has no head or foot adjustable mechanism.

At the shoulder region, the white and bronze pod suspensions are the softest for shoulder sleepers. The back and hip regions have firmer grey pods and light grey suspensions. Each pod suspension can be made over 20 percent firmer by inserting a red firmness adjustment piece inside the pod cavity. There are about 70 pods per section. Each of these pods can be interchanged in position so each side can be customized for personal comfort.

SILVERSTAR GT

The Silverstar GT is a versatile slat suspension with firmness adjustments for the lumbar region and over 50 firmness adjusters at the ends of the slat.

This model can be adjusted to be firmer or softer at both ends of the every two slats. There are red tabs at each end. Each tab can be dialed to a firmer or softer position. The middle section can be firmed up by moving the plastic firmness adjusters in the back region. You can see red tabs at the ends of every two slats.



ADVANTAGES OF AXEL BLOOM

There are Two Types of Adjustable Suspensions:

TYPE ONE - TRADITIONAL PROFILE

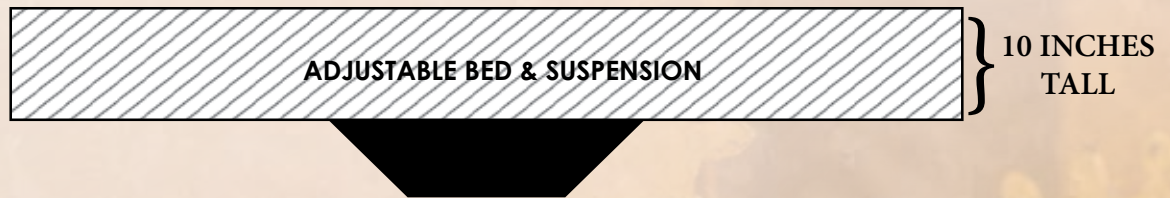

Electric motor installed below suspension frame

→ Disadvantages caused by motor location:

- Cannot place suspension on flat platform bed or box spring
- Limited storage under suspension
- 10 inches tall

TYPE TWO - AXEL BLOOM LOW PROFILE ADJUSTABLE - ONLY 5" TALL!



Electric motor installed into side of suspension

→ Advantages of AXEL BLOOM low profile:

- Can place suspension on top of platform bed or box spring
- Fully usable storage space below suspension
- Simple to clean under suspension
- Light & Easy to install
- Example: King Size consists of two Half-king sections.
- Each section weighs approximately 75 lbs



INSTALLATION OPTIONS FOR LOW PROFILE SUSPENSION

The Axel Bloom adjustable suspensions are easy to install onto an existing bed frame.

The suspensions have a low profile of 5 inches in height. The electric motor is built into the side of the suspension frame. This allows easy placement of the suspension on a box spring or a platform bed.

Option One

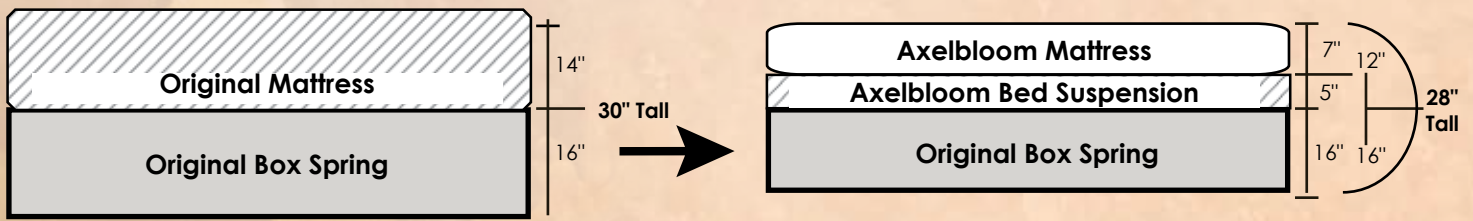

Option Two



Option Three



Option Four

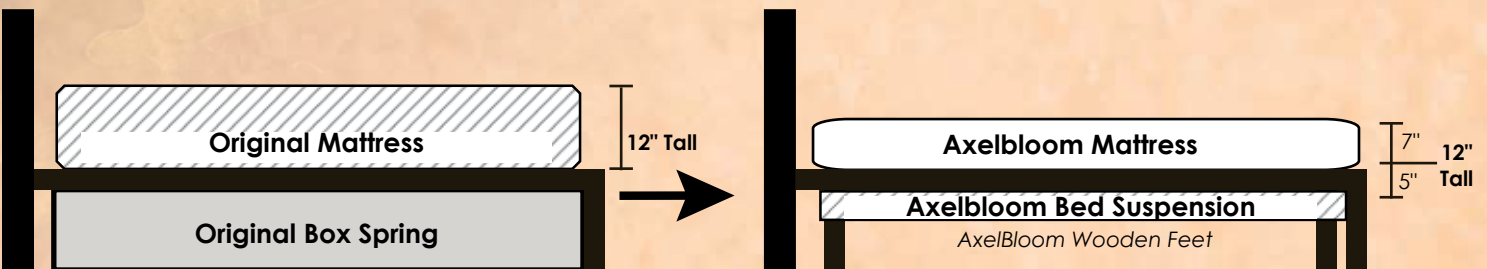

*Figures are for illustration purposes only and is not drawn to scale



AXEL BLOOM ADJUSTABLE BEDS

DOPPELFLEX MX2

- **2 motors: Slats Only**
 - Combined head & shoulder
 - Combined knee & foot
- Standard cable remote (Optional wireless remote)
- **Most Popular Model**



QUATTROFLEX MX2

- **2 motors: Hybrid Slats + Pods**
 - Combined head & shoulder
 - Combined knee & foot
- Standard cable remote (Optional wireless remote)



UBERFLEX MX3

- **3 motors: Hybrid Slats + Pods**
 - Head
 - Lumbar
 - Combined knee & foot
- Wireless remote with 2 memory settings



UBERFLEX MX4

- **4 motors: Hybrid Slats + Pods**
 - Head
 - Lumbar
 - Knee
 - Foot
- Wireless remote with 2 memory settings



AUSTROFLEX EL3

- **3 motors: All Pods**
 - Head
 - Lumbar
 - Combined knee & foot
- Wired or optional Wireless remote w/3 memory settings
- Highest knee angle
- Motors installed under frame
- Not suitable for platform bed



AXEL BLOOM ADJUSTABLE BEDS

DOPPELFLEX MX2

- Most suitable for **firmer back** support
- Adjust lumbar firmness with slat slides
- Recommended for serious adverse back conditions
- Very high vertical head angle

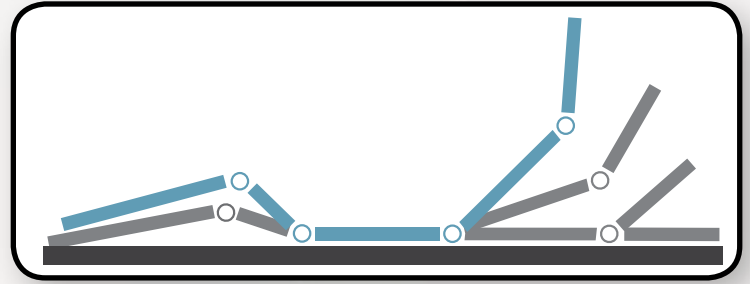

QUATTROFLEX MX2

- For **supple** and **firm body** conditions
- Hybrid suspension combines pods for flexibility and slats for firmness
- Four firmness settings by pod color and inserts: white (soft), black (medium-firm), and black with red inserts (firm)

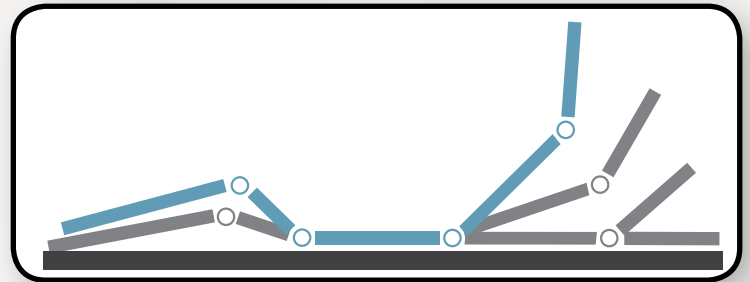

UBERFLEX MX3

- **The All-Rounder**
- Hybrid suspension combines pods for flexibility and slats for firmness
- Adjust pod firmness by rotating ring
- Very high vertical head angle
- 6 modes of firmness
- Independent head elevation

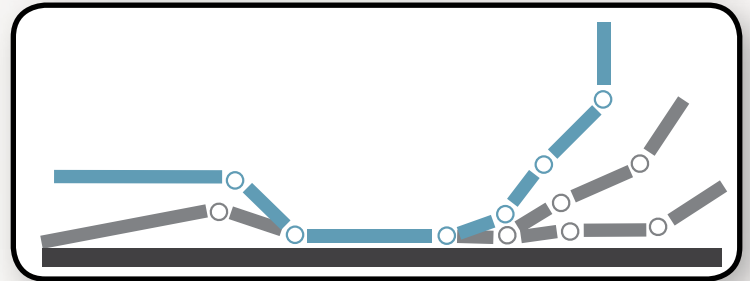

UBERFLEX MX4

- **Highest foot** elevation
- Independently controllable w/4th motor
- **Most customizable** system
- Hybrid suspension combines pods for flexibility and slats for firmness
- Adjust pod firmness by rotating ring
- Independent head elevation
- Highest vertical head angle

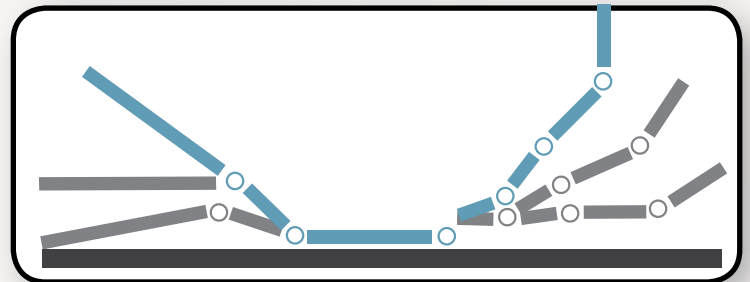

AUSTROFLEX EL3

- **Most comfortable head and shoulder** support
- Highest knee elevation
- All pod suspension for maximum flexibility
- **Highest knee** elevation
- **4 firmness settings by inserting adjusters into soft and medium pods**

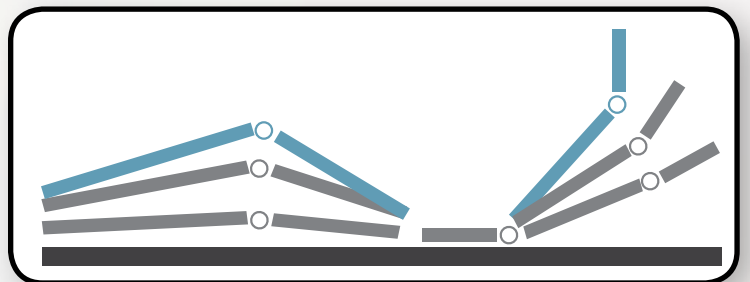

RV INSTALLATION EXAMPLES

PREVOST XL2



TIFFIN PHAETON



LANDMARK 365



RV INSTALLATION EXAMPLES

**MONACO EXEC
42SBW**



**GULF STREAM
MONTAJ**



**NEWMAR
VENTANA4037**

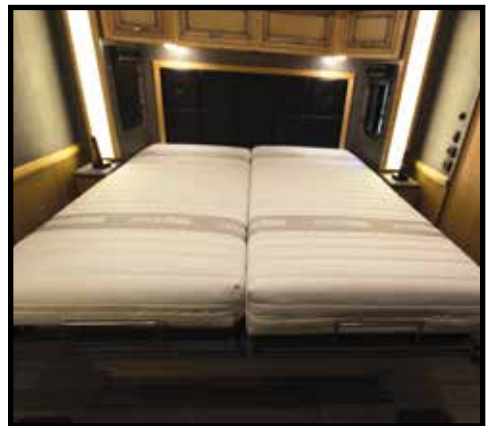

RV INSTALLATION EXAMPLES

Installation for Hinged Storage Access

Place Two Half Suspensions on Existing RV Bed Support/Storage Box

OPTION 1 (Normal Frame Length)

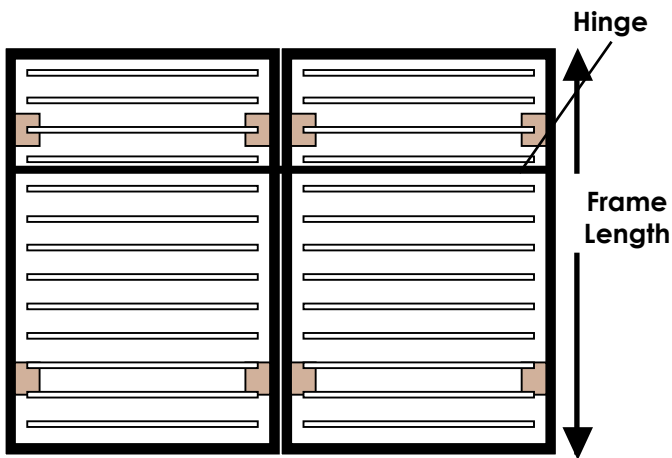

OPTION 2 (Custom Shorter Frame Length)

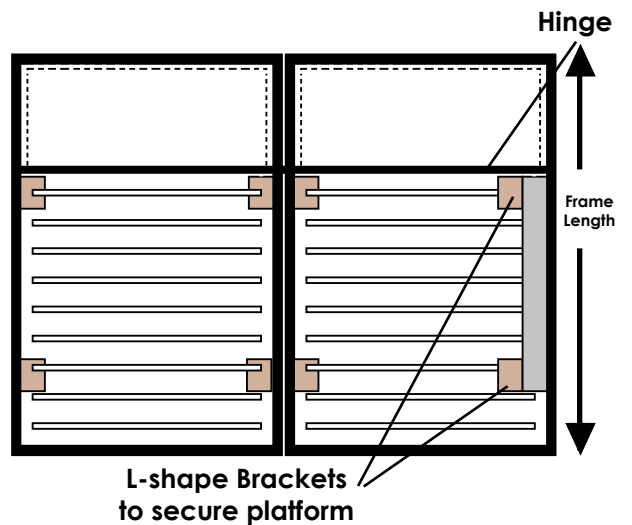

Normal Frame Length
(Frame does not bend at hinge)

Custom Shorter Frame Length
(Frame bends at hinge)

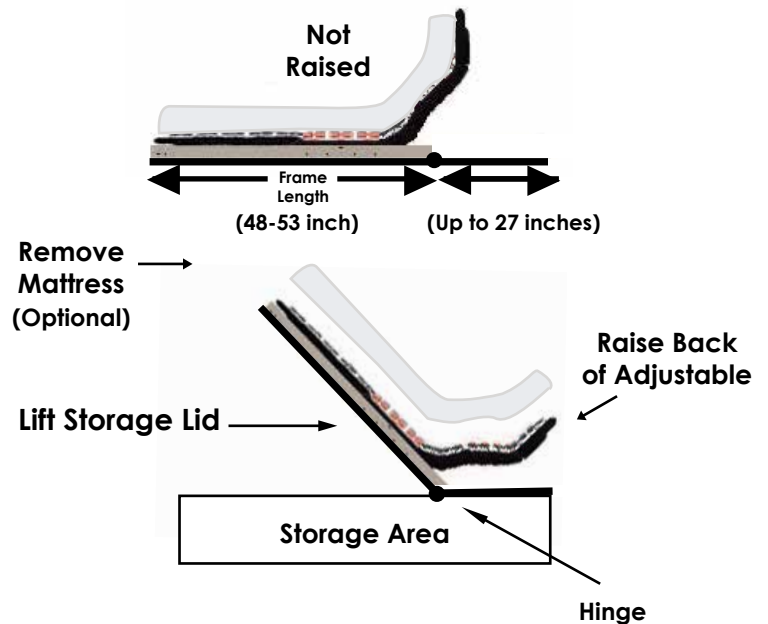
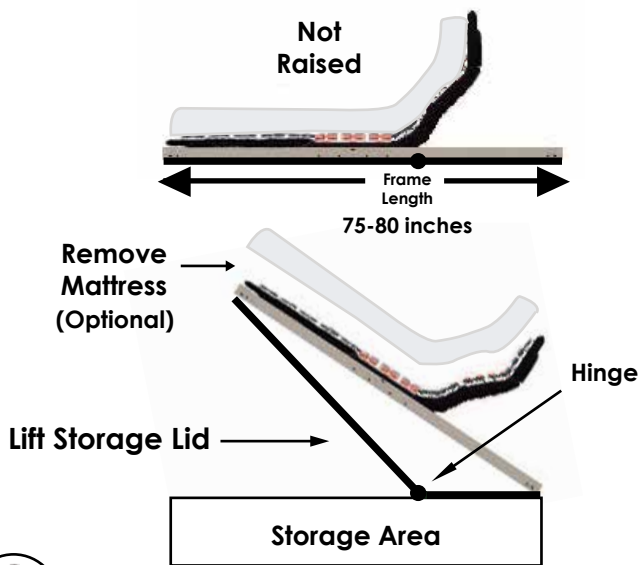

RV INSTALLATION GUIDE

Option One Example: Standard Frame Length 80 Inch

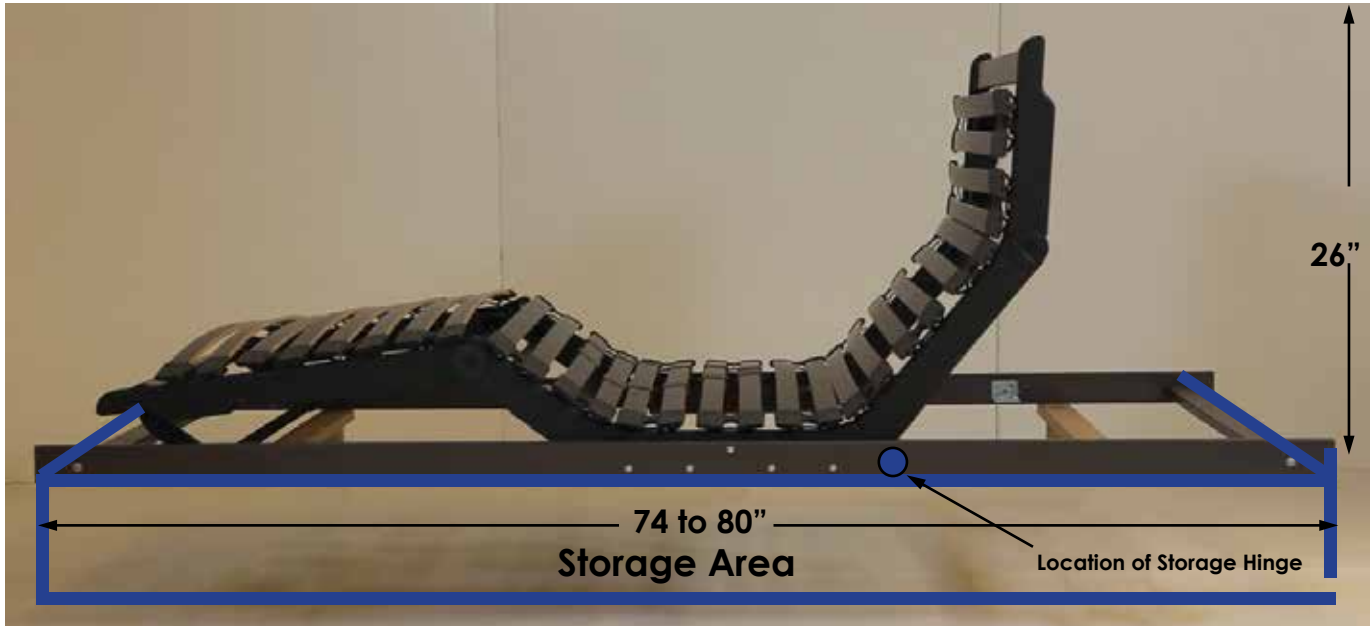

Length Can Be From Approx. 74 to 80 Inches

Shorter Frame Length 53 to 70 Inches



Shorten by 10-30" for Elevated Storage Access

29



HOW TO ACCESS STORAGE COMPARTMENT?

OPTION ONE: Place Adjustable Section On Platform and Lift Foot For Access to Storage



Foot & Back Raised Up



Foot Raised Up to Access Storage

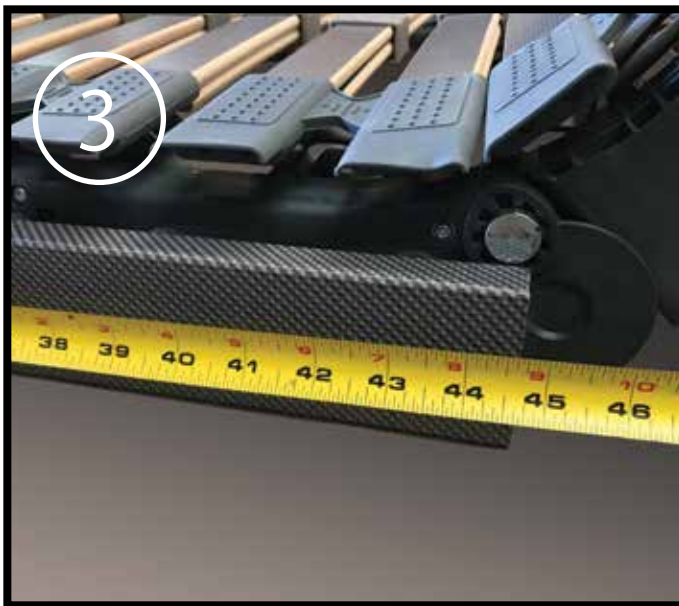

**Close Up of Hinge Location
44.5 Inches from Foot**



**View Looking at Raised
Foot Section**



HOW TO ACCESS STORAGE COMPARTMENT?

OPTION TWO: Remove Storage Platform, Place Adjustable Bases on Top of Crossbeams

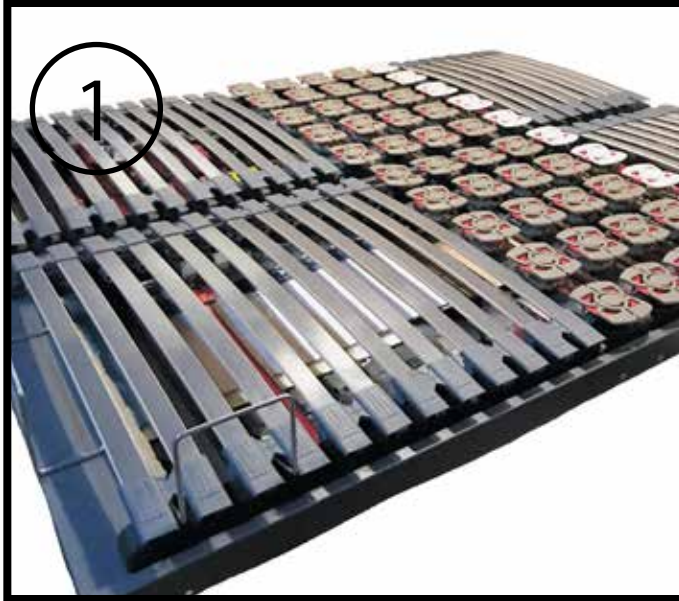

Adjustable Suspensions Resting on 3 Crossbeams Over Storage Box

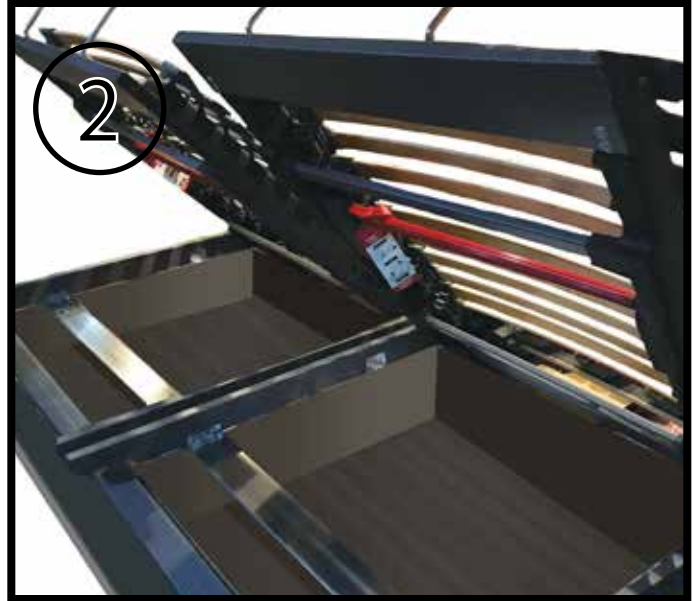

Two Foot Sections Raised for Access to Storage Box

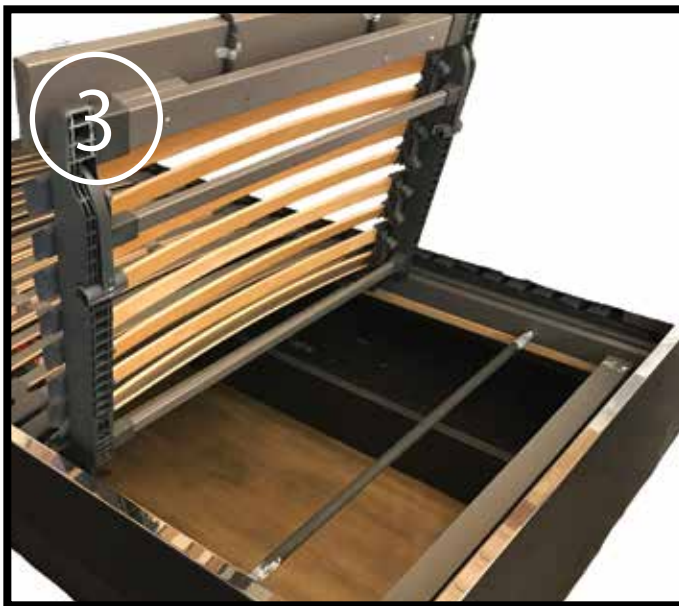

Lift Foot Section for Storage Space Access



Lift Head Section for Storage Space Access



ADJUSTABLE BED INSTALLATION OPTIONS

INSTALLATION FOR SILVERSTAR, QUATTROFLEX AND UBERFLEX SUSPENSIONS

Option A

Box Spring with Steel Frame

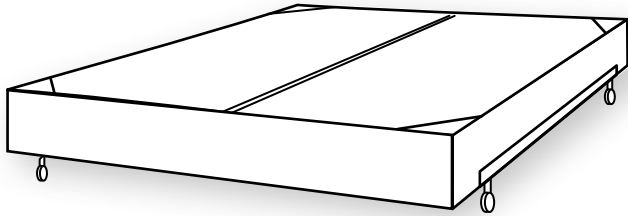

Bed Frame with Slats

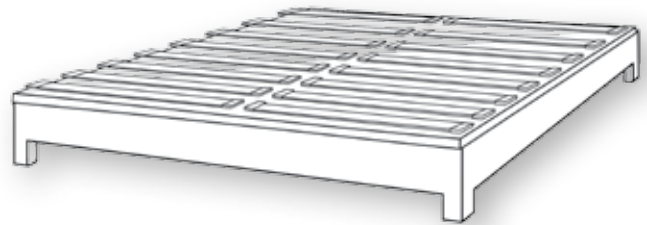

You may use your existing Box Spring or Slats with the Silverstar or Quattroflex suspensions. Leave your box spring or slats in place and put the new adjustable suspension on top.

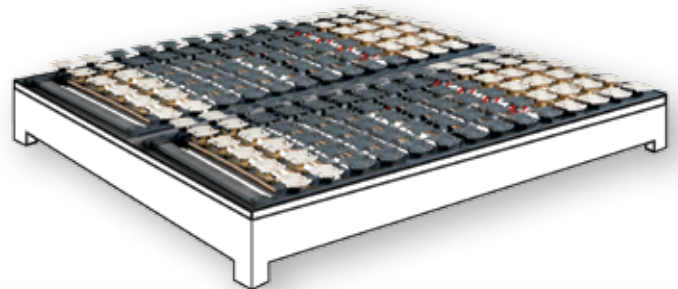
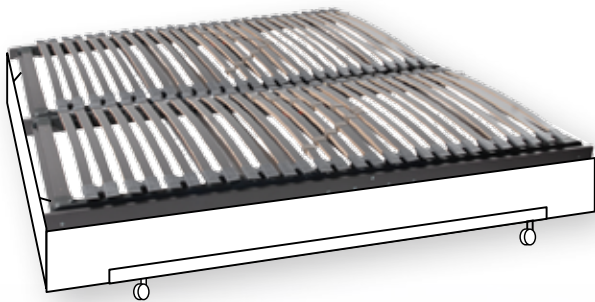

Pictured above are the Silverstar MX2 (left) resting on box spring and metal frame, and the Quattroflex MX2 (right) resting on an existing bed frame with slats. These suspensions can also be placed on any flat surface, such as a platform bed.*

*NOTE: There is no need to remove old slats or the box spring because the Quattroflex and Silverstar motors have a low profile (see diagram below.) The motors are built into the frame of the adjustable suspension.



In flat position, motor is not visible from exterior



ADJUSTABLE BED INSTALLATION OPTIONS

INSTALLATION FOR THE AUSTROFLEX SUSPENSION

Option B

The Austroflex suspension **cannot** be placed directly on a platform bed or box spring because of the location of the motor.

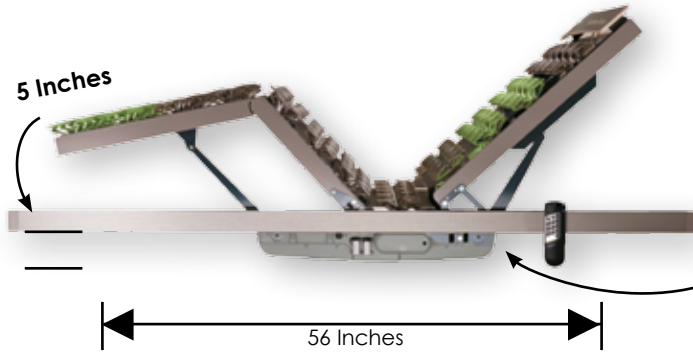

Motor needs 5" of vertical space below the bottom of side frame and 56 inches of horizontal space.

Box Spring

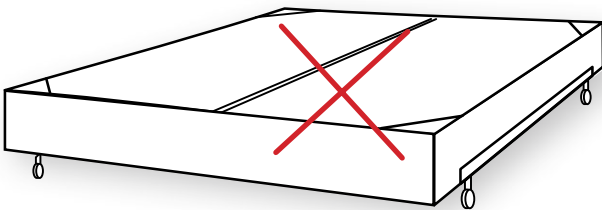

Bed Frame with Slats

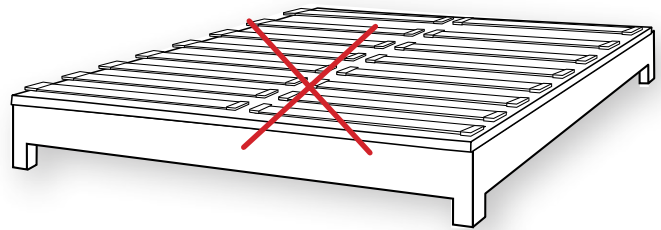

Special Instructions for Austroflex Suspension in a Bed Frame with Slats

First, remove the Slats to make space for the Austroflex motor. Beneath the suspension, approximately 5 inches of vertical space and 56 inches of length is needed (see *diagram above and below*). Then place the Austroflex suspension on the remaining slats.

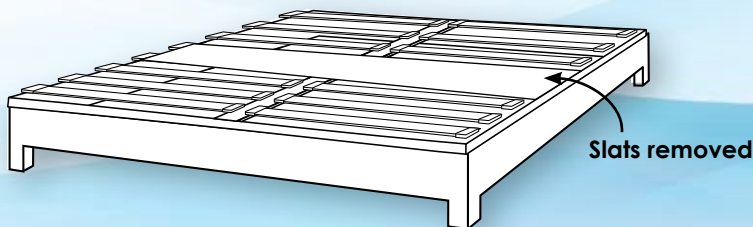

Suspension with slats removed to make space for the Austroflex motor

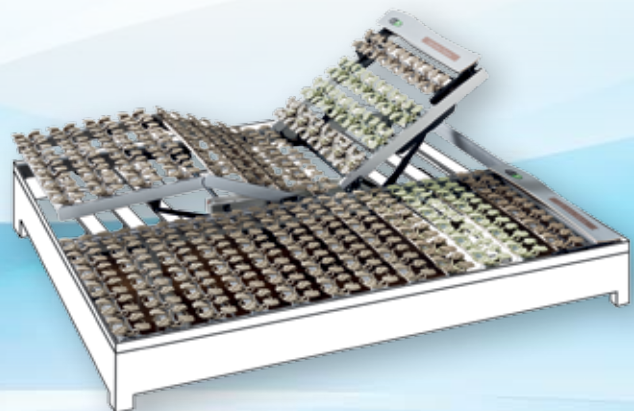

Austroflex suspension installed on slat bed frame



ADJUSTABLE BED INSTALLATION OPTIONS

INSTALLATION OPTIONS FOR SILVERSTAR, QUATTROFLEX, UBERFLEX AND AUSTROFLEX SUSPENSIONS

Option C: Bed Frame with Ledges

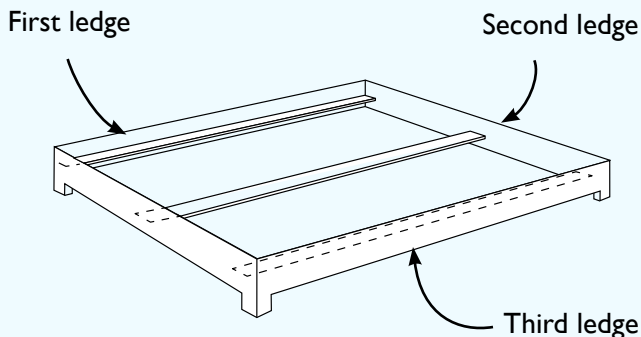

Install ledges. Then place the adjustable system to sit right on top of the ledges.

Option D: Bed Frame with Suspension Support Kit

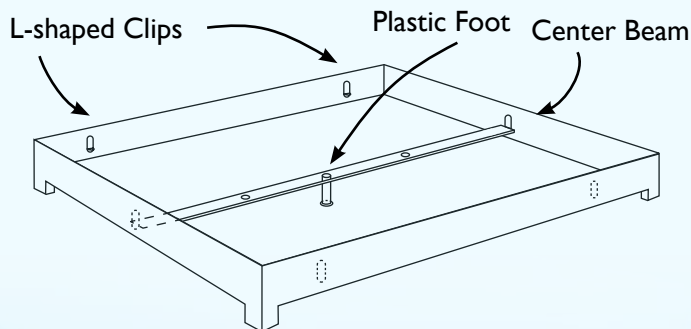

Install the Axcel Bloom Suspension Support Kit into your existing bed frame. Place the suspension on top.

SUSPENSION SUPPORT KIT INCLUDES:

1. **Four** L-shaped Adjustable support clips with face plates. Screws are included.
2. **One** center beam with two clips and faceplates to anchor the beam to the head and foot section. Screws are included.
3. **One** height-adjustable plastic support foot.

Option E: Stand Alone Suspension with Feet

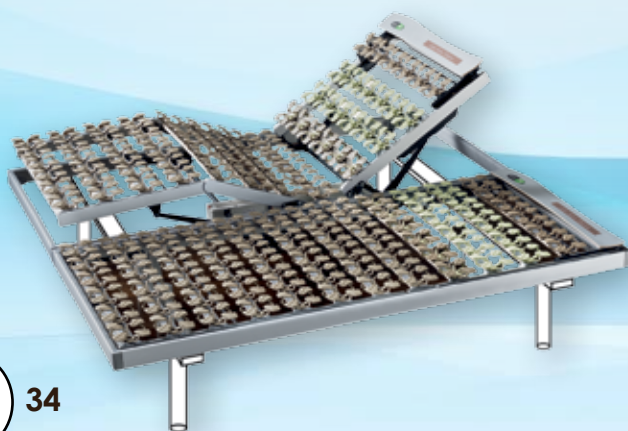

Install the Feet and Cross Beams to the underside of the suspension. This option can be used by itself or can be placed into an existing bed frame.

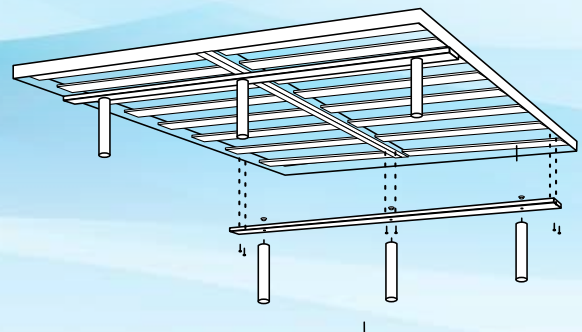

WHAT AFFECTS THE HEIGHT OF YOUR MATTRESS?

TOTAL HEIGHT TO TOP OF MATTRESS = 22"

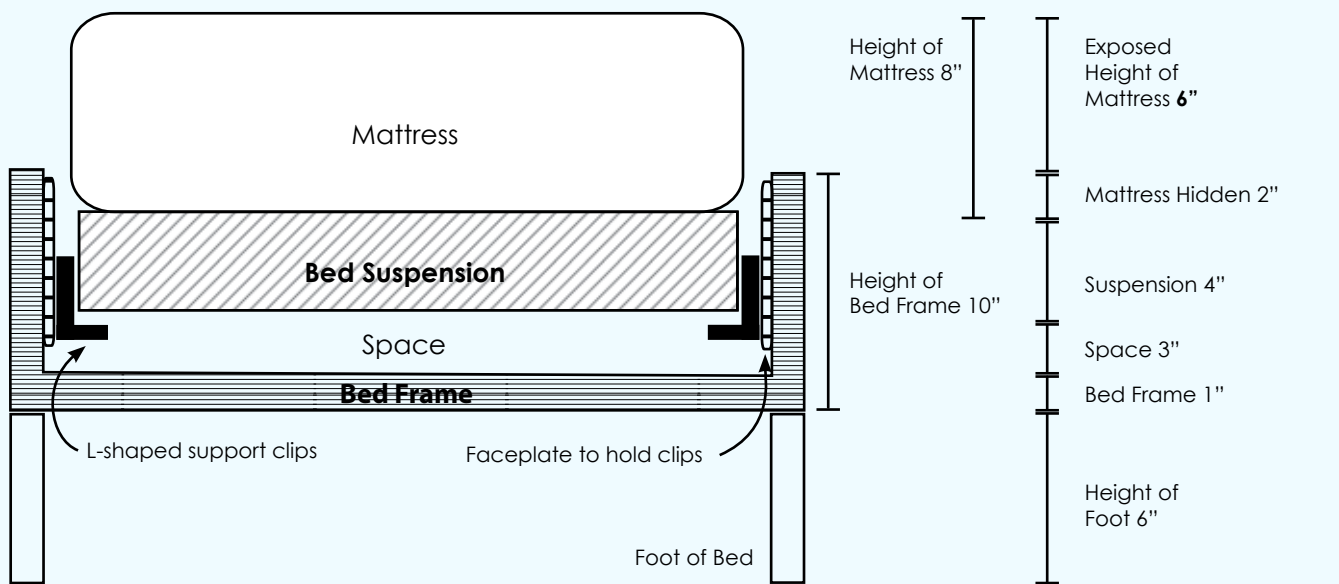

*Figure is for demonstration purposes only and is not drawn to scale

TOTAL HEIGHT TO TOP OF MATTRESS = 24"

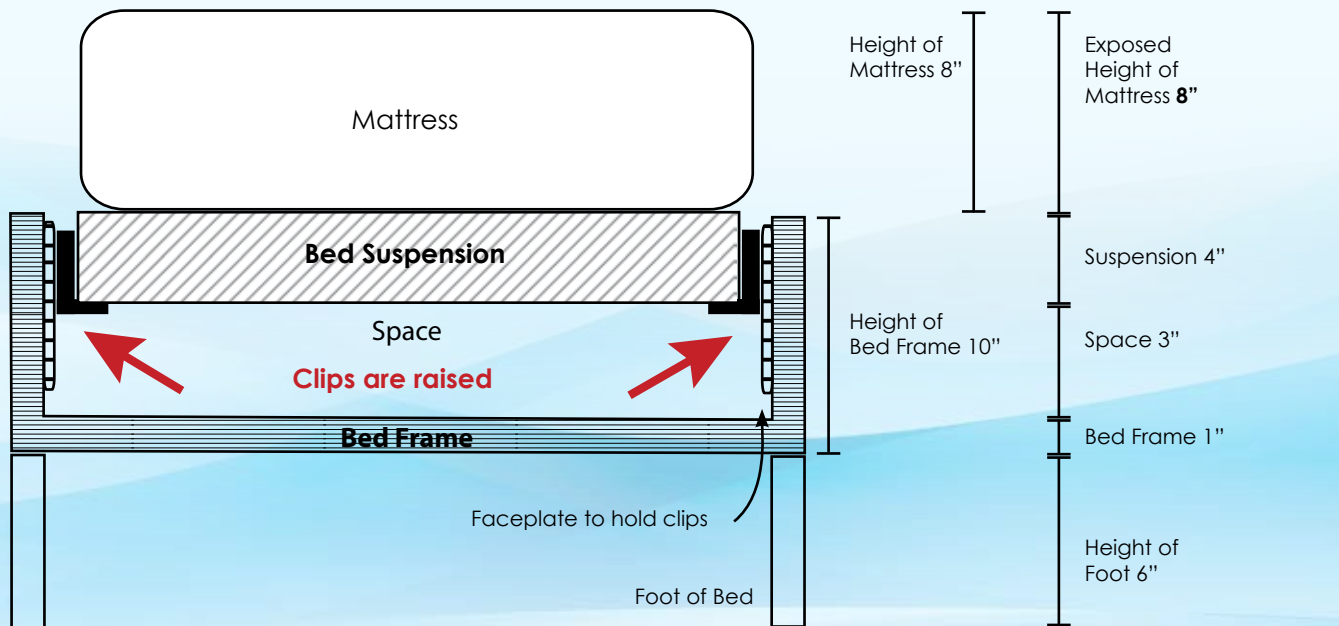

*Figure is for demonstration purposes only and is not drawn to scale



THE ALLES EXTENDABLE OAK SOFA BED

A TRUE CHAMELEON

The Alles Sofa is everything you want it to be



**Table &
Sofa**



Armchair



**Queen
Guest Bed**



**Bed or
Chaise**



THE ALLES EXTENDABLE OAK SOFA BED

A SINGLE ALLES SOFA



TWO ALLES SOFAS SIDE-BY-SIDE



CUSTOMER LOCATIONS



Two years ago I was diagnosed with **GERD**. One of the recommendations from my doctor was to sleep with my upper torso elevated at least 30 degrees. My husband and I decided to look for an adjustable bed. We are very pleased with our new bed, **we feel well rested every morning**, I don't have any symptoms of **GERD** and my aches and pains have disappeared. And the bed looks beautiful in our bedroom.

Ivonne, Pasadena CA

After decades of searching for the perfect bed, we have now found it in the Austroflex. This bed is a marvel of engineering. This bed, which is as attractive as it is comfortable, represents at last the answer to our long-sought combination of softness of surface with firmness of support, and provides as a bonus the never imagined features of washability and alterability over time.. It is worth noting that **we purchased the Austroflex without ever seeing it in person**, or touching it, all through internet and telephone exchanges.

Eleanor Dozier & Zulma Iguina, Newfield NY

We love our new bed, and it's funny because I can't wait to go to bed tonight! I had an excellent sleep last night and didn't wake up until morning. With our old bed, I would wake up a few times a night because I was uncomfortable or my arm had fallen asleep. We truly do love our new bed! It's truly refreshing. Also, just as much as the great bed, both my wife and I thought your service was excellent...You do more than sell great sleep systems, you take care of people! That type of customer service is getting harder to find...You and you staff have done a great job! Thank you.

Lana Seidler, Los Angeles CA

Sleep glorious Sleep. I haven't had a good night's sleep in years. I thought I had a-top-of-the-line mattress and box spring. Yet, I would wake up numerous times during the night to either adjust my head or knee pillow to provide me with some kind of comfort and back support. Last night was the first night I slept on my new Axelbloom bed and frankly it was **the best sleep I've had in years. For the first time, to sleep without a pillow between my knees.**

C. Baggetta, Sherman Oaks CA



CUSTOMER TESTIMONIALS

When I visited Axel Bloom, I was walking with a cane. My back was hurting and I could not turn my neck to look over my shoulder. I got the Austroflex Electric Adjustable bed and Austroflex EMC 180 mattress. I usually wake up at least 5 times a night. The first night sleeping on the new bed system took some adjustment. However, on the 2nd night, I raised the head of the bed a little. I went to sleep at 9 p.m. I woke up once at midnight to use the restroom. I went back to sleep until 5 a.m. I had never slept this long through the night before!

When I woke up in the morning, I was lying on my back and I could feel the blood pumping through my back area. I have had no back pain since then.AND I have no problem turning my neck now. The mattress molds to my neck, even when I am sleeping on my side. The mattress is soft enough that it compresses where my shoulder is, and it still supports my neck.

I am not worried about travelling alone anymore, because, now I can walk without a cane and I have no more pain!

Erna Debarro, Los Angeles CA

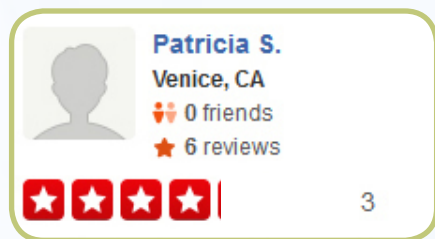

I bought an Axel Bloom bed a year ago. At the time I had ongoing back issues and when I got up in the morning (had a sleep number bed at the time), I was always bent over with back pain.

First morning after the Axel Bloom bed was installed, no back pain. Thought that was a bit too soon to give credit to the bed so just thought it was a coincidence. I was totally wrong there. Since the installation of this bed system that has always been my experience. When I get up in the morning my back is great, I am not hunched over as I had been before and thought was my new "normal".

I am just amazed that this bed change made such a huge difference in this back situation.

This doesn't even get to the amazing service and sales information we got when we originally went to the store. And, stunningly, we were actually undersold, told we didn't need the upgrades that I was totally ready to go for. Plus we got such a thorough explanation of the technology of the bed (mathematical me loved that part, others may not). Don't forget to get their pillows. We took them home the day we purchased the bed and fell monumentally in love with them.

I just can't say enough about this experience. The folks at the store are amazing, give you so much good information, don't pressure you or try to make you buy something and really, maybe they should, just cause it would be to your benefit.

As I said, I have now had this bed for at least a year, and OMG I just thing I have died and gone to heaven.

There are very few purchases I have made in my life that more than a year later, I can still feel giddy about.



We bought our beds 2007 and have never regretted it. The mattress DW800 Euro is unbeatable. Firm, yet not too firm, it allows a comfortable sleep, and together with the adjustable motorized bed frame it is the most beneficial sleeping solution available. Other reviewers have already mentioned the benefit

of sleeping with the increased head part. My wife used also the foot increase regularly. After 7 years, one cannot see traces of use on the mattress. One other huge advantage is that the mattress is relatively light and not too thick. One can easily lift it for changing covers and sheets or to turn it over, if needed. And it comes with a washable cover! Extremely practical. The service provided by Yong and Bonnie is very personal. This is their life and to help their clients is their mission. Friendly, knowledgeable and accommodating.



Why not **Sleep** on the **Best?**



Axel Bloom LLC

1105 Gayley Avenue
Los Angeles
California 90024 USA
Phone: 1-866-696-8387
www.axelbloom.com